

1958 MERCURY

FOUR GREAT SERIES WITH SPORTS-CAR SPIRIT AND LIMOUSINE RIDE

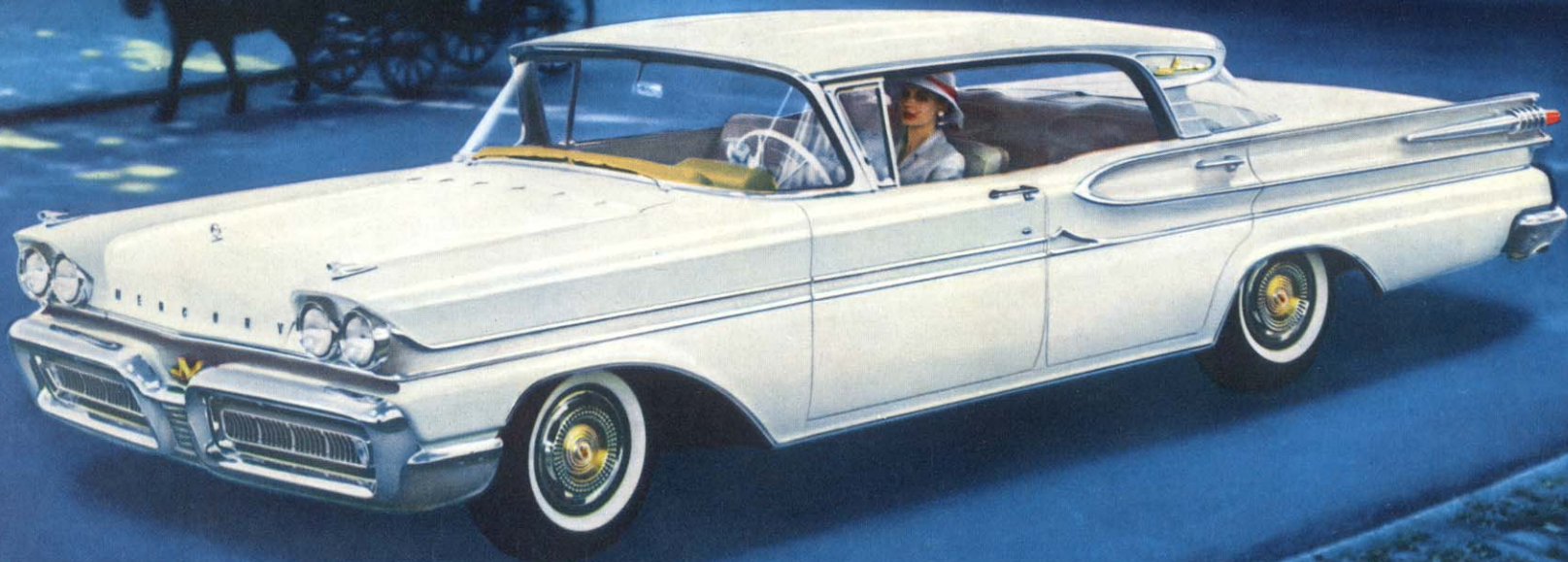

PARK Lane

MAGNIFICENCE UNLIMITED . . . BY MERCURY



Mercury Park Lane Series

MORE THAN 18 FEET OF QUIET COMFORT—

CONTOURED IN DISTINCTIVE STYLING

For 1958, Mercury adds an all-new series—the Park Lane—Magnificence Unlimited. It's a car of surpassing beauty, of distinguished fabrics, hand-crafted appointments. In size and comfort, it compares with many of the biggest, costliest cars.

It has the solid heft of a big car, too—with more generous proportions to relax in. And, the Park Lane is so easy to handle.

You travel the miles in a wonderful realm of ease, thanks to new Limousine Ride—smooth, jolt-free, relaxing. Limousine Ride, an exclusive in all '58 Mercurys, gives you the greatest array of bump-smothering features ever put between you and the road. *And there's another big plus in the Park Lane's ride—it's "library quiet" . . . because of a specially designed "Sound Blanket" which is three to four times more effective in blocking under-the-hood and road sounds than ordinary insulation.*

The Park Lane has a standard 360 hp Marauder V-8 engine with Cool-Power Design that answers instantly to your command—teamed with a new Multi-Drive automatic transmission as standard equipment that lets you "tailor" your driving to any road or traffic situation. In performance, the Park Lane compares with any car—including those that cost hundreds of dollars more.

Every Park Lane has, as standard equipment, a Keyboard Control that puts every driving motion at your fingertips—power steering that eliminates 80% of the work of steering, turning and parking—power brakes that adjust themselves.

At left, Park Lane Phaeton Coupe, Solid-Toned Tuxedo Black with Marble White Side Molding.



PARK Lane Phaeton Sedan

Here is styling that's advanced and new—with exciting new touches everywhere—long, deep-channeled side projectiles—thin, strong roof line—new outrigger taillights—new front fender ornaments. The hood is long, low and front-hinged for greater safety . . . the front end is massive, yet finely detailed. Solid-Toned Marble White.

PARK Lane Convertible

Slip behind the wheel. Start the 360 hp Marauder V-8 engine—notice how softly it purrs. Put down the top (one finger does it) and head for your favorite stretch of road. This is living—you're bossing a Mercury Park Lane Convertible—statuesque in line—big in dimension—great to handle. The top allows unequalled vision when it's up—folds nearly out of sight when it's down. Solid-Toned Flamingo Red.

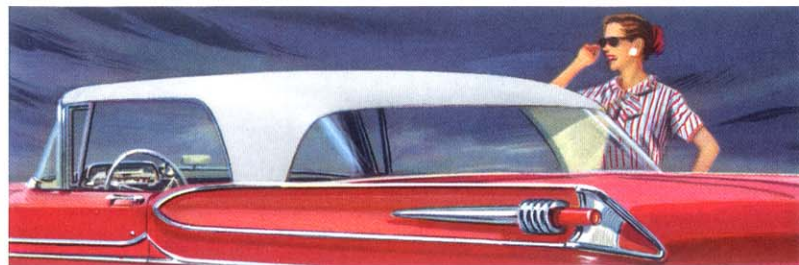



Interior decor is created specially to match the mood of Mercury's distinctive styling

EVERY 1958 MERCURY ENCLOSSES YOU IN A WORLD OF RICHNESS AND ELEGANCE

EVERY DETAIL IS DESIGNED TO PLEASE YOUR EYE AND TOUCH

Interiors are the very essence of luxury in the famous Mercury tradition. See new weaves—new, fine fabrics—imaginative colors—all are masterfully color-coordinated with Mercury's exterior styling. Feel the soft, crisp tailoring—revel in its casual comfort. Carefully tooled metalwork adorns the inside—so refined and so subtle in design you hardly know it's there.

Mercury's instrument panels are so designed that every control on the instrument cluster is within easy reach of the driver and easy to read. The overall designs blend beautifully with the interior decor.

Park Lane interiors are illustrated. There are 33 different fabrics in beautiful color combinations available on Montclair and Monterey models.

Mercury presents a complete family of revolutionary new Marauder V-8's with **COOL-POWER** design

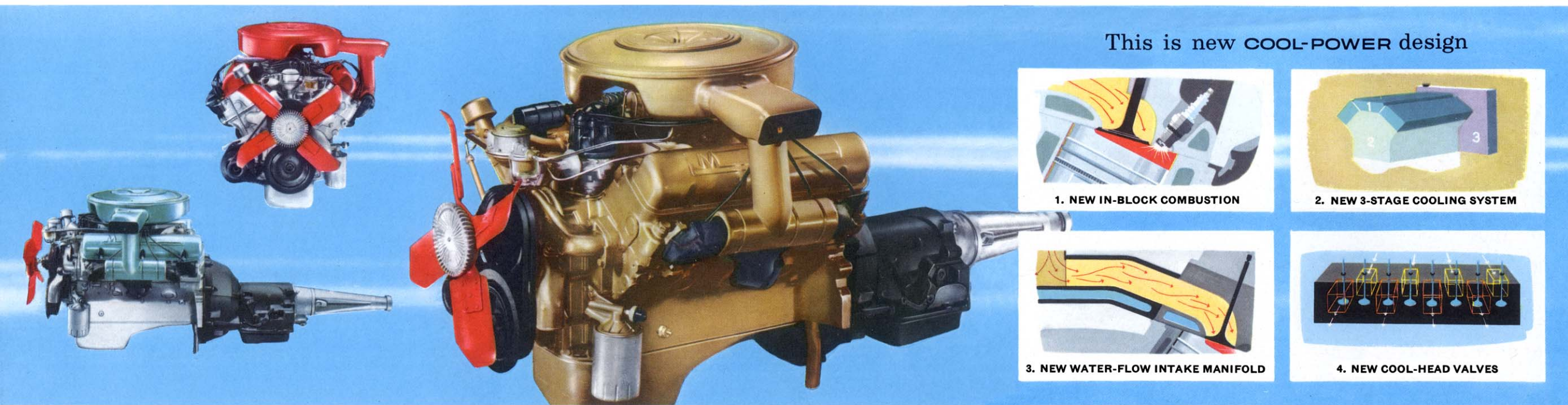

This is new **COOL-POWER** design



1. NEW IN-BLOCK COMBUSTION



2. NEW 3-STAGE COOLING SYSTEM

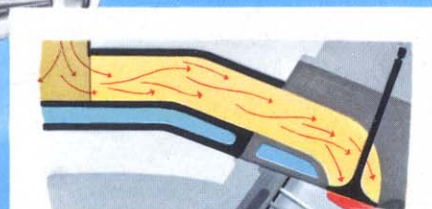

3. NEW WATER-FLOW INTAKE MANIFOLD

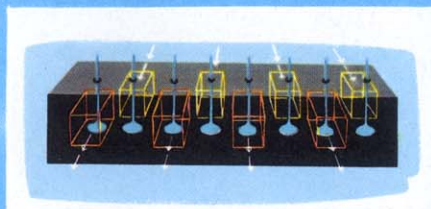

4. NEW COOL-HEAD VALVES



**THE 400 HP SUPER MARAUDER V-8...
OPTIONAL ON ALL MERCURY MODELS**

For those who want the ultimate in fine car performance, Mercury offers the 400 hp Super Marauder with 430 cubic inch displacement, 10.5 to 1 compression ratio.

312 hp Marauder V-8 for Montereys and Commuters

330 hp Marauder V-8 for Montclairs, Colony Parks and Voyagers

360 hp Marauder V-8 for Park Lanes

Marauder engines represent a revolutionary development in automotive engines and are a tremendous step forward in delivering higher standards of efficiency, economy and performance to every Mercury model. No more hot spots—no power fatigue—no lagging pickups—just Cool-Power delivering the peak of performance. Every Marauder

boasts new engineering advances: over-square design with larger pistons—more efficient 4-barrel Thermo-Matic carburetor—higher compression ratio, 10.5 to 1—biggest engines in Mercury history, from 383 cubic inches to 430 cubic inches.

As illustrated, Cool-Power Marauder engines feature—1. Combustion chambers in the block,

instead of cylinder head. Heads are subjected to less heat. Straight-walled combustion chambers eliminate carbon-forming pockets—keep engine operating at peak economy. 2. Three stage cooling system; (1) to cylinder heads and intake manifold; (2) to block; (3) to radiator. This means smoother all-weather performance. 3. Intake manifolds water-

jacketed to maintain better control of intake temperatures and reduce hot-weather starting problems. This results in longer engine life, better fuel economy. 4. In a 1958 Mercury, no two exhaust valves (in red boxes) are next to one another. They are alternated with the cooler intake valves (in yellow boxes) to eliminate power-robbing hot spots.

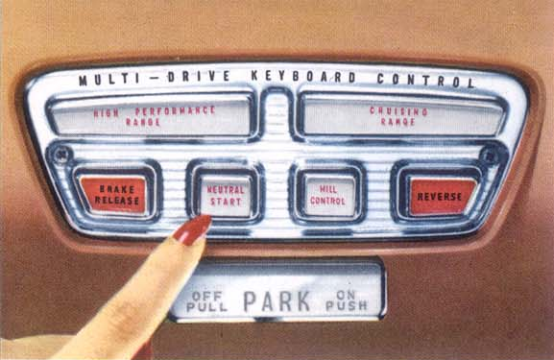

Mercury's brilliant combination of road-smoothing features gives you new **Limousine Ride...**

New Multi-Drive Merc-O-Matic

New Multi-Drive Transmission gives you a far more precise selection and control over your driving ranges than ever before. You "pick" your performance. Here's how: for instant, quick response, you touch the *High Performance* bar. For top highway going, smooth and economical, you use the *Cruising Range* bar. For engine braking when descending steep grades, you use the *Hill Control* bar. It's that easy . . . touch a bar, tailor your performance.

In addition, *Cruising Range* offers a unique feature that *automatically* keeps you from ever rolling backward when you are stopped on an incline with the engine running. No need to use the brake or keep your foot on the accelerator.

All '58 Mercurys equipped with Merc-O-Matic Transmission and a 383 cubic inch engine have a high-economy rear axle that gives you greater gas mileage. Multi-Drive Merc-O-Matic is standard equipment on Park Lane models. Regular Merc-O-Matic is standard on Montclair, Colony Park and Voyager models—and optional on Monterey and Commuters.



IT'S LIKE LOUNGING IN YOUR LIVING ROOM

You'll discover riding in a 1958 Mercury is an exciting, new motoring experience—quiet, jolt-free, relaxing—because Mercury's wonderful new Limousine Ride acts like a magic carpet . . . softening and smothering bumps and noises. The heart of Mercury Limousine Ride is a *sturdy, heavy frame . . . evenly balanced weight distribution . . . full-cushion shock absorbers* that provide rapid rebound control over rough roads, yet give a soft, "just paved" feel on average road surfaces . . . *swept-back ball-joint front suspension* that "pulls" front wheels over bumps instead of pushing into them . . . and a *lower center of gravity* that helps Mercury hug the ground.

Working as a unit, they produce Mercury's new Limousine Ride.

For matchless riding comfort, choose new Air Cushion Ride—full air suspension—cradles you on air instead of springs

Mercury's new Air Cushion Ride is a tremendous advance in riding comfort and safety. You ride completely supported on air.

Air Cushion Ride acts exactly like a balloon being rolled over a rock. As the hand moves the balloon forward over the rock, the hand stays on a straight, level plane . . . the balloon absorbs the impact! Like the balloon, Air Cushion Ride sponges up the shocks, softens the ride, keeps The Big M straight and level.

In addition, a unique "self-leveling" feature automatically adjusts The Big M to an even, level position regardless of road or load. You ride level *at all times*, no "tail low" appearance when the back seat's full. This is the *ultimate* in riding comfort and enjoyment. (Air Cushion Ride is optional on all Mercury models.)



Mercury Montclair Series

BEAUTIFULLY SCULPTURED . . . DISTINCTIVELY DETAILED . . . MARAUDER-POWERED

Montclair is a name famous in Mercury history, and this year it will add even more laurels to its fame. There are six great Montclair models for 1958, including the new Montclair Turnpike Cruisers—each with Mercury's distinguished new styling and grace—each with generous proportions.

This is a long, low Mercury—heavy too, but so very light on its feet, and so easy on you. You've never driven a more considerate car—handles with the ease of a sports car—but has the ride of a limousine. Smooth, solid—steady-as-you-go.

Underneath its broad hood is one of the most advanced V-8 engines ever designed—the 330 hp Mercury Marauder with revolutionary, new Cool-Power Design. Efficient, energetic, willing and able to take you anywhere. If you want a truly young-minded car, adept at maneuvering and creating good impressions, a 1958 Big M Montclair is for you.

MONTCLAIR 4-DOOR TURNPIKE CRUISER

Everything about this 4-door Turnpike Cruiser will appeal to you: styling that's fresh and clean . . . Breezeway Ventilation . . . a retractable back window . . . high-level air intakes . . . side running lights. Flo-Toned Jamaican Blue Metallic and Marble White.

Montclair Turnpike Cruiser—no other car offers you as many exclusive features



Power-Operated Back Window—A Mercury exclusive! Touch a button and the back window quickly and quietly disappears. And notice the modern, slim, overhanging roof.



Skylight Dual-Curve Windshield—Wraps up as well as around at the side. Roof-level air intakes at each side of the windshield provide a gentle stream of fresh air to interior.



Luxurious Interiors—Mercury Turnpike Cruiser upholsteries are specially chosen vinyls and fabrics. High-styled in superb fashion shades—durable and flexible—richly beautiful.



MONTCLAIR 2-DOOR TURNPIKE CRUISER

Here is easy-going gracefulness. Long, low lines—slender roof—new distinctive taillights. And this grace extends to its road manners, too. A smooth, road-hugging feel . . . and efficient performance from a 330 hp Marauder V-8. Flo-Toned Autumn Beige and Golden Dust Metallic.



MONTCLAIR CONVERTIBLE

To fit your moods and moments—the Montclair Convertible. Feeling light and carefree? Down with the top and the sun and breeze are your guests. Rainy day? Then up with the top and be on your way. Snug, comfortable and cradled gently by new Limousine Ride. Interiors are tailored in colorful, durable vinyls. Solid-Toned Vineyard Blue with Marble White Side Molding.

And that vinyl-coated top! The back window wraps all the way around at the sides, providing 1024 square inches of visibility—more than many sedans. It folds down nearly flush with the rear deck when top is down.

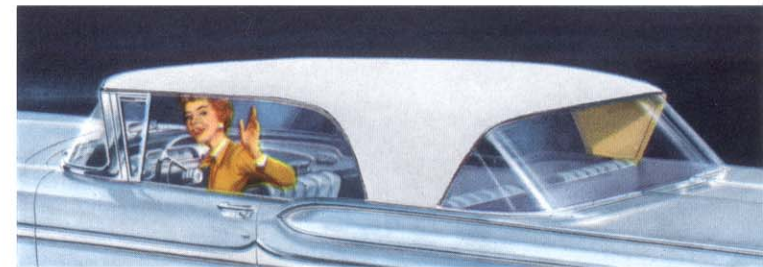



MONTCLAIR PHAETON SEDAN

Pile the whole family—*plus their gear*—in this sleek beauty and there's still loads of room. Style? Every Mercury has distinctive styling and this beautiful hardtop is a prime example. Long and low—with a look that says "be my guest." Flo-Toned Emerald Metallic and Marble White.

Notice how the roof slopes off gently at the rear, then cuts straight back in. This gives the car a distinctive look—and provides the rear seat passengers with increased side vision and headroom.



MONTCLAIR 4-DOOR SEDAN

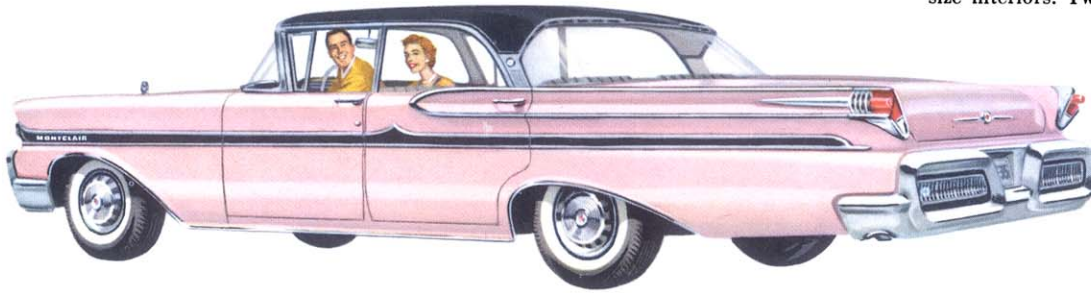

All the styling of a hardtop and the spaciousness of a sedan are yours. Style in terms of fresh, inviting lines—big, wide windows, concealed center pillars. Spaciousness in terms of family-size interiors. Two-Toned Rose Pink and Tuxedo Black.

MONTCLAIR PHAETON COUPE



Easy does it in this hardtop. *Easy* on the eyes—long, low and hefty looking—this is advanced styling. And this Mercury is a solid, road-hugging sweetheart to drive and ride in. *Easy* on your pocketbook, too. Solid-Toned Jamaican Blue Metallic and Vineyard Blue.



Mercury Monterey Series

DISTINGUISHED IN LINE AND DETAIL . . . VALUE-PACKED . . . ECONOMICAL MARAUDER V-8 PERFORMANCE . . . SURPRISINGLY LOW COST

The Mercury Monterey offers you all the advantages of advanced styling . . . big-car size and glamour . . . luxurious Limousine Ride and wonderful 312 hp Marauder V-8 performance . . . and yet it's priced just an easy step above the low-priced cars.

Undoubtedly, this is America's biggest car value—a brilliant blending of size, luxury and unusual performance. Smooth, gently flowing lines reach back to a wide rear deck. Luxurious interiors are the height of fashion. To make your driving easier and safer, you have Mercury's complete line of power assists from which to choose.

Drive a Mercury Monterey—discover a car with extra pleasure, performance and luxury at a very modest price.

MONTEREY PHAETON SEDAN

At left, the Monterey Phaeton Sedan, Two-Toned Mayfair Yellow and Marble White.

Also available on all Monterey models is a new High Fashion Interior Decor featuring distinctive interior door paneling, luxurious seat fabrics and deep-piled carpeting.

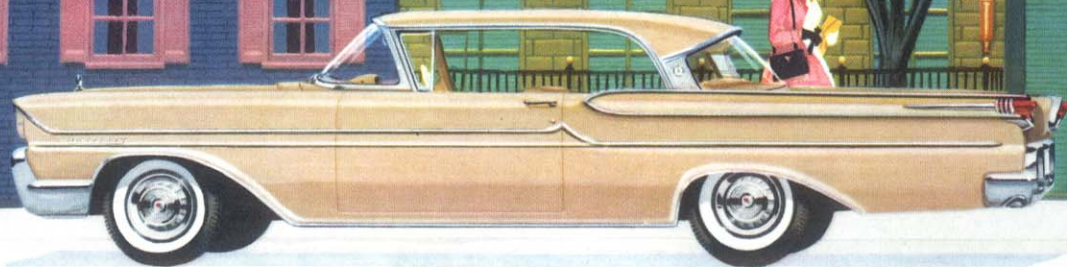

MONTEREY PHAETON COUPE

This Monterey Phaeton Coupe is a new concept in hard-top styling, comfort and convenience. You get unusually big and wide windows . . . the smoothness of Mercury Limousine Ride. Solid-Toned Golden Dust Metallic.



MONTEREY CONVERTIBLE

You'll wish the days and nights were longer when you own this beauty. There's the promise of fun in every line . . . and it's well fulfilled. Flo-Toned Mayfair Yellow and Oxford Gray Metallic.



MONTEREY 2-DOOR SEDAN

Lowest priced of all Mercurys, yet it gives you more than any other car at the price: refined lines, long and low—masterfully tailored interiors. Two-Toned Parisian Green and Holly Green Metallic.



MONTEREY 4-DOOR SEDAN

By any measure, this Mercury stands out! Its lines are classic—clean, crisp, definite in character . . . with beautifully concealed center pillars. Luxurious interiors blend with the overall styling theme. And this is truly a big car . . . in size, weight and power, but priced just above low-priced cars. Two-Toned Burgundy Metallic and Marble White.

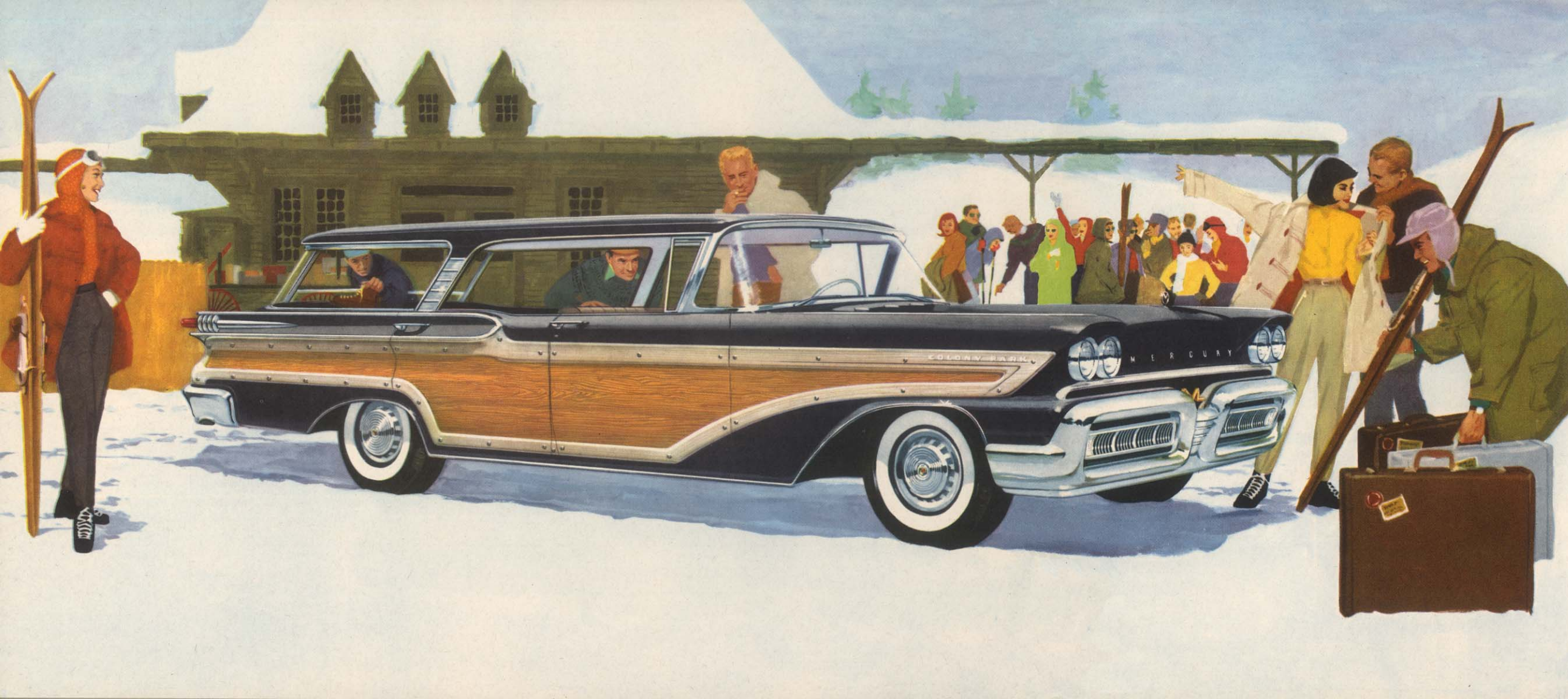

Big M Hardtop Station Wagons

SUPERLATIVE PERFORMANCE • TRUE PASSENGER-CAR COMFORT • LIMOUSINE RIDE • NEW FEATURES

Mercury's 1958 station wagons with Hardtop Styling again lead the field—with spirit to match their beauty and size. They offer superlative performance plus comfort in abundant measure: Marauder engines with Cool-Power Design, and the industry's only Limousine Ride—a new kind of ride built into every Big M.

Every Mercury station wagon has Hardtop Styling. The three awkward pillars common to many other station wagons are replaced in Mercury wagons by a single, graceful, extra-strong roof support. This gives passengers the full-view expanse of a *true* hardtop. In addition, Mercury's retractable back window eliminates the old-fashioned liftgate, permits all-clear loading.

To make your 1958 station wagon even more enjoyable, Mercury offers many other features—including Advanced Keyboard Control Merc-O-Matic Transmission, new, larger Super-Safe Self-Adjusting Brakes, Quadri-Beam Headlamps; and such options as Climate Dial Air Conditioner and Heater, Rear Radio Speaker, and Speed Limit Safety Monitor.

THE COLONY PARK

Most masterful expression of station wagon luxury you can buy. To relax in it is to experience comfort without compromise . . . to own it is real enjoyment. Luxury features include wood-grained, steel paneling and fully carpeted floor and tailgate. Illustrated is Colony Park 4-door, 6-passenger—Solid-Toned Tuxedo Black. (Also available in 4-door, 9-passenger model.)

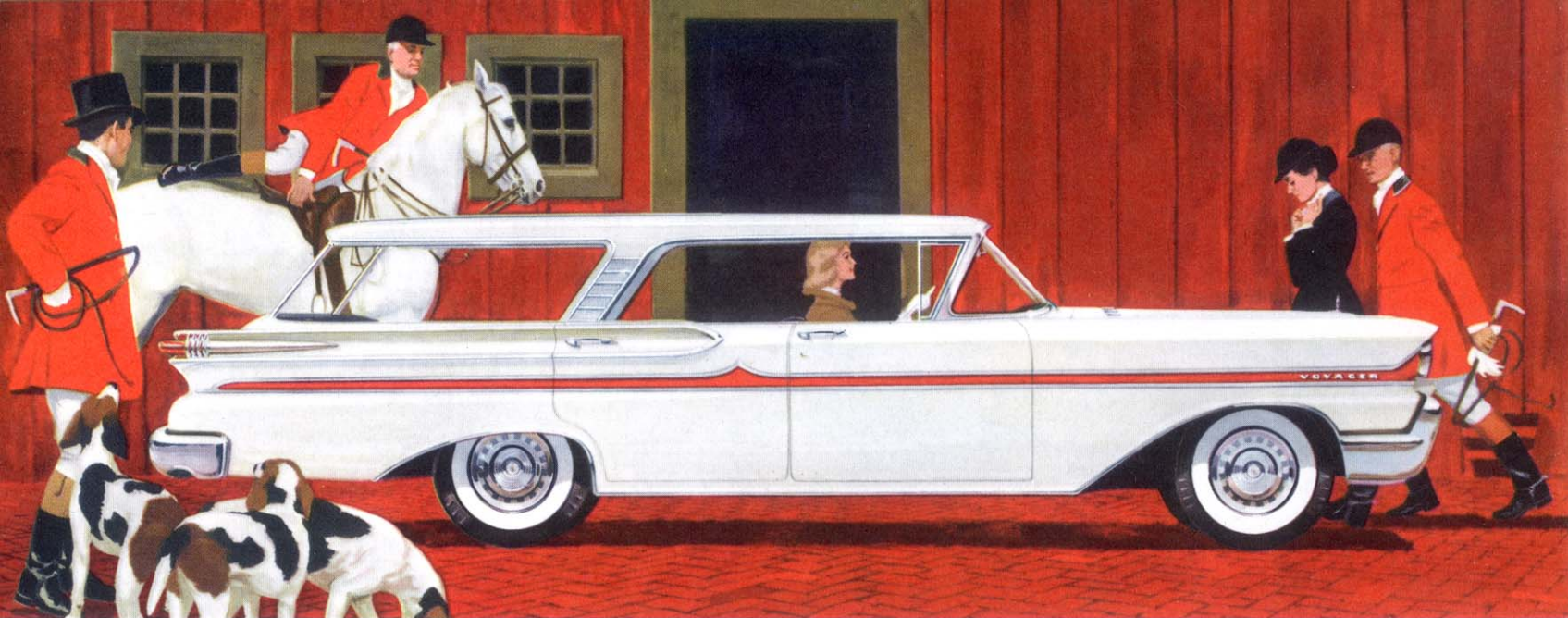

VOYAGER 4-DOOR, 6-PASSENGER
Solid-Toned Marble White with Red Side Molding
(Also available in 4-door, 9-passenger model.)

The Voyager Series

Equally wonderful for handy hauling, casual calling, and formal affairs, the Mercury Voyager affords all-purpose convenience. Glamorous and smart, it's a car designed to excite the more discriminating members of the station wagon set. Handsome it is, appointed tastefully throughout, and every spacious inch is *usable* big. Just a few of the features you'll find on all 1958 Big M station wagons are front-hinged hood, safety lock for second seat, toe-set parking brake, and slide-type safety door locks.



Colorful, tailored interiors – both luxurious and durable – in every Big M Station Wagon

VOYAGER 2-DOOR, 6-PASSENGER
Two-Toned Jamaican Blue and Marble White



Every interior element is created expressly for station wagon living; fabrics of easy-to-clean, leather-like vinyls and nylon-faced body cloth . . . artfully blended textures of enduring beauty . . . a rainbow of exciting colors—for vibrant contrast or subtle distinction. And you can choose from more than a score of stunning exterior paint colors. From the fully integrated instrument panel and lounge-like contour seats to scuff-resistant floor coverings, you are surrounded by luxury available only in Mercury station wagons.



COMMUTER 2-DOOR, 6-PASSENGER
Flo-Toned Marble White and Mayfair Yellow



COMMUTER 4-DOOR, 6-PASSENGER
Two-Toned Autumn Beige and Golden Dust Metallic

The Commuter Series

Three big-value models all with Marauder-smooth performance . . . exclusive Limousine Ride . . . true hardtop design . . . features not available *at any price* in other make station wagons. Every Commuter has massive bumper-grille combination, Quadri-Beam headlamps, distinctive taillights that say "Mercury" at a glance. Never before has so much size, power, comfort, and so many years-ahead features been offered in a station wagon at such modest cost.



COMMUTER 4-DOOR, 9-PASSENGER
Solid-Toned Holly Green Metallic with White Side Molding

A new concept of practical spaciousness — for maximum convenience

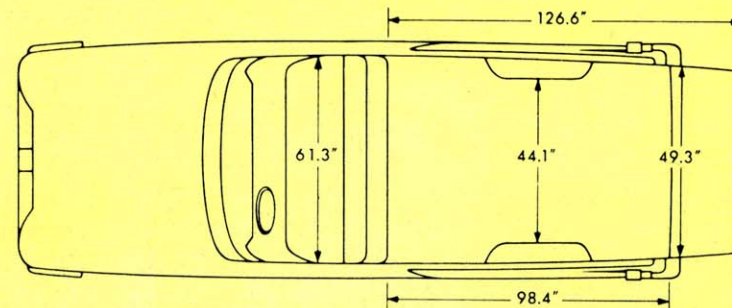

Every 1958 Mercury station wagon has more than 87 cubic feet of all-clear load space, big enough to carry a rowboat *inside*. It's bigger in all the other dimensions that count, too! For example, when the tailgate is down, Mercury provides the largest, most versatile, *usable* area of any station wagon on the road. The retractable back window, standard on

every Big M station wagon, disappears into the tailgate to completely eliminate the cumbersome liftgate, making the tailgate a flat, open, loading platform. It's just as easy to transform this Saturday worker into a Sunday sedan. You merely fold up the second seat in 6-passenger models, and add the removable rear seat in 9-passenger models.

For the ultimate in driving pleasure, safety, convenience ... select from Mercury custom-designed accessories



SPEED LIMIT SAFETY MONITOR

A new approach to automotive safety. Set your desired speed, up to the legal limit, on the handsome dash-mounted dial—then relax and concentrate on your driving. Once you exceed your pre-set speed, a gentle bell sounds reminding you to slow down. Optional on all Mercury models.



POWER SEAT THAT "REMEMBERS"

Now you can *dial* your most comfortable seat position! What a convenience! Set your favorite position on the dial located on the instrument panel and forget it—but *the seat won't!* When the ignition key is turned off, the seat automatically moves backward for easier entry or exit—returns to your "set" position when the key is turned on. Optional on all Mercury models.



SPARE CARRIER

This distinctively styled spare carrier complements your Big M's advanced design . . . accentuates its feeling of length and lowness. Also shown are red plastic, rear bumper pod reflectors that serve you well two ways: at night, they quickly signal your presence to cars behind—are tastefully bordered and sectioned with chrome to give your Mercury an extra touch of distinction.

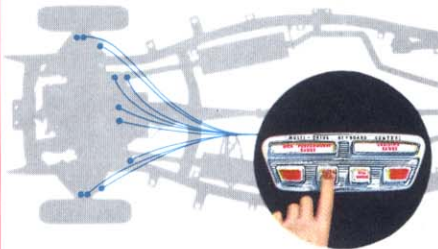

POSITIVE POWER LUBRICATION

You can lubricate your Mercury *automatically!* Every time you start the car, the front suspension and steering points get a quick lubrication. This improves the ride, saves time, reduces the need for periodic lubrications. For additional lubrications while driving, you just press the button on the instrument panel.

GLAMOUR GROUP

• **Wheel-opening finish molding** — A line of stainless steel highlights and protects front wheel openings and lower side panel. • **Rear deck dress-up kit**—Anodized aluminum license plate frame with protective glass window, and bright metal "wings" accent the rear bumper styling. (Not available on station wagons.)

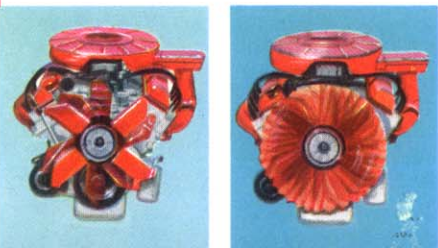
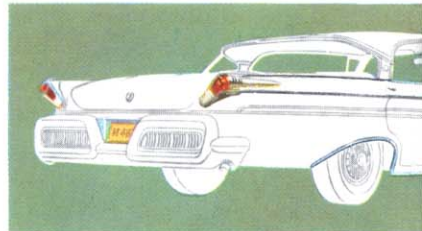

POWER-BOOSTER FAN

Rotates normally for cooling when car is traveling slowly. At highway speeds, when fan is not needed for cooling, fan clutch automatically limits fan rotation to low-noise level—saving power other cars usually waste. Boosts performance, cuts fuel consumption. Indicator on instrument panel tells when Power Booster is operating. Optional on all models.

NEW CLIMATE DIAL GIVES FINGER-TIP CONTROL OF AIR-CONDITIONER OR HEATER



Turn just *one power-operated dial* and you get the kind of climate you want from this terrific combination air-conditioning and heating system. There's a wide range of settings. "Cool" for high-volume, draft-free refrigerated air, free from dust, pollen and excess moisture. The "Heat" settings tailor the warmth to your liking quickly. No more flipping switches, or opening vents—*one dial control* does it! (Standard with Mercury Air Conditioning.) Also optionally available on Park Lane models is Mercury's Climate Dial Heater and Defroster. It super heats, defrosts and ventilates.



FULLY INTEGRATED PANEL ACCESSORIES

For modest extra cost, you can have accessories that add much to increasing driving comfort, safety and peace of mind, such as . . . the smartly styled special steering wheel of gleaming chrome and ivory—with impact-absorbing design . . . the padded instrument panel—five times more energy-absorbing than same thickness of foam rubber.

Mercury Travel-Tuner Radio (at left). In the city, signal-seeking tuning picks up powerful local stations. In the country, it automatically selects stations above a minimum strength. Push-button radio also available.

VISUAL AID GROUP

Every Mercury owner can appreciate the added convenience and safety this special group affords.

- Back-up lights
- Non-glare inside rearview mirror
- Tinted glass
- Windshield washer

COURTESY LIGHT GROUP

Practical and inexpensive—this group is a convenience you're sure to want for your Big M—so useful every night you drive.

- Ashtray light (silhouettes ashtray)
- Courtesy lights (both front doors)
- Glove box and map light
- Luggage compartment light

To Enhance Big M Station Wagons

Special New Accessories

OTHER ACCESSORIES—

And optional features to make your driving easier, safer, more comfortable include:

Power Steering	Illuminated Compass
Power Brakes	Traffic Signal Reflector
Power Windows	Locking Gas Tank Cap
4-Way Power Seat	Interior Plastic Sun Visor
Dual Exhaust System	Plastic Seat Covers
Coaxial Rear Seat Speaker	Ventilated Seat Cushion
Electric Antenna	Contour Floor Mats
Rear-Mounted Twin Antennas	Tissue Dispenser
Curb Signals	Safety Seat Belts
Curb Buffers	Child's Safety Jacket
Door Edge Guards	Padded Sun Visors
Window Shields	Full-Disc Wheel Covers
Hooded Rearview Mirror	Fender Shields
Conical Rearview Mirror	Luggage Carrier
Spotlight and Mirror	Luggage Carrier Cover
	Engine Compartment Light

POWER-OPERATED RETRACTABLE BACK WINDOW

This retractable window lowers into the tailgate to provide refreshing ventilation, and all-clear loading when the gate is open. Available separately as a power option; manual-operated version standard on every wagon.

LUGGAGE CARRIER

This low-cost accessory enables you to carry all your luggage, sports gear, or camping equipment in addition to a wagon-load of passengers. Sturdy, handsome. Available for either permanent or demountable installation.

REAR RADIO SPEAKER

Another new Mercury "first" for station wagons, this speaker "carries" the sound to every passenger with crisp clarity and richness. It is installed behind a grille in the right rear corner of the wagon—has independent volume control.

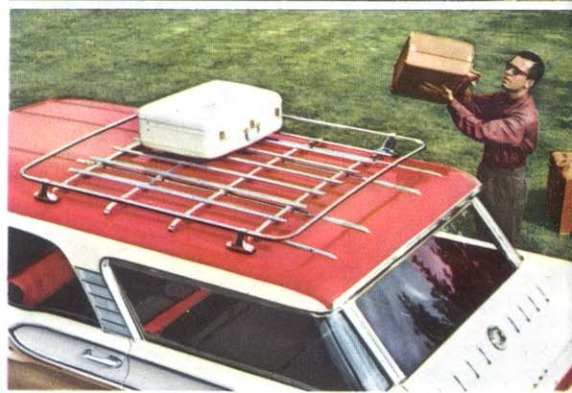

Mercury adds new meaning to the word performance

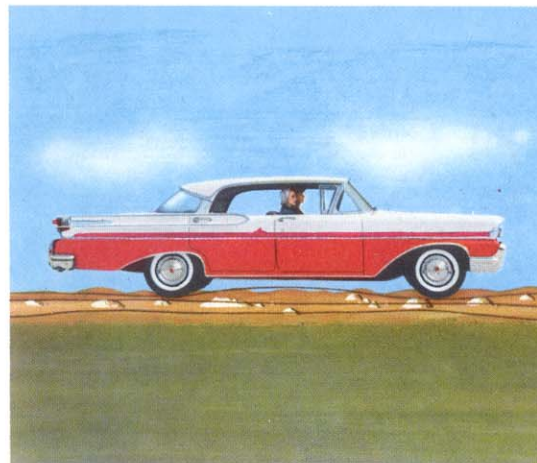

SUPER SPRINGING ACTION

Specially designed Full-Cushion Shock Absorbers are an important element of Mercury performance. They provide fast, super-effective control of spring action on rough and average roads alike, at all speeds—give you a smooth, jolt-free ride.



EASIER HANDLING

The lower suspension arms of the Ball-Joint Front Suspension are swept back slightly so that front wheels are "pulled" over bumps instead of being "pushed" into them. You get a softer, smoother ride, plus better control under all driving conditions.



BRAKES ADJUST AUTOMATICALLY

Here is another important Mercury safety and convenience feature. Large, Super-Safe Self-Adjusting Brakes help prevent swerving, provide surer, safer stops. Brakes are always in correct adjustment—they *automatically* compensate for lining wear.

MAJOR SPECIFICATIONS—1958 MERCURY

ENGINES

MONTEREY AND COMMUTER MODELS: 312-hp, 383 cubic inch displacement. Torque rating, 405 lb.-ft. Compression ratio 10.5 to 1.

MONTCLAIR, VOYAGER AND COLONY PARK: 330-hp, 383 cubic inch displacement. Torque rating, 425 lb.-ft. Compression ratio 10.5 to 1.

PARK LANE SERIES: 360-hp, 430 cubic inch displacement. Torque rating, 480 lb.-ft. Compression ratio 10.5 to 1. Dual exhaust. Assembled with Multi-Drive Merc-O-Matic. Also, optional at extra cost for Turnpike Cruiser models.

SUPER MARAUDER: 400-hp, 430 cubic inch displacement. Compression ratio 10.5 to 1. Three 2-barrel carburetors. Available as special order option with Multi-Drive Merc-O-Matic for all 1958 Mercury models.

BASIC CONSTRUCTION: One-piece V-8 block. In-block combustion chambers. Water-cooled intake manifold. Cool-Power Design eliminates hot spots. Aircraft-type low-friction pistons. Cylinder bore, 4.3 in. Piston stroke 3.3 in. for 383 cu. in. engines and 3.7 in. for 430 cu. in. versions.

FUEL SYSTEM: Low-silhouette 4-barrel Thermo-Matic carburetor. Dual temperature-controlled carburetor air intakes. Dry-type carburetor air filter.

ENGINE LUBRICATION: Full-pressure lubrication with simplified oil line pattern. Internally mounted rotor-type pump. Capacity, 5 quarts. Forced-air crankcase ventilation.

ELECTRICAL: 12-volt system. High-capacity dual-drive generator with low cut-in speed. High torque "Folo-Thru" starter. Combination centrifugal-vacuum spark advance control. Front-mounted distributor. Battery sizes—66-plate battery for vehicles with conventional or overdrive transmission; 78-plate battery with Merc-O-Matic transmission.

OVERHEAD VALVES: Free-turning, rotating type valves. Intake valve-head diameter 2.08 inches with 383 cu. in. engines; 2.14 inches with 430 cu. in. versions. Exhaust valve-head diameter 1.77 in.

COOLING SYSTEM: 3-stage cooling with 2½ quart capacity (with optional heater). 3 thermostats adjust cooling capacity to needs.

EXHAUST SYSTEM: Center-outlet exhaust manifold with extra-large passages. Dual exhaust standard on Park Lane models.

POWER TRAIN

MERC-O-MATIC TRANSMISSION: Combination of fluid torque converter and 3-speed planetary gear train. Mechanical Keyboard Control drive selector. Multi-Drive Merc-O-Matic (standard in Park Lane) affords choice of low-gear or intermediate-gear starts. Oil capacity 10¼ quarts.

CONVENTIONAL TRANSMISSION: Selective gear type with three speeds forward, one reverse. All gears helical. Constant-mesh second gear. Overdrive with 4th forward speed (.72 to 1 ratio) optionally available for Monterey and Commuter models.

REAR AXLE: Hypoid gears with straddle-mounted pinion gear. Rear axle ratio is 2.69 to 1 with 312-hp and 330-hp engines, and 2.91 to 1 with 360-hp and 400-hp engines. All air conditioned vehicles have 2.91 to 1 rear axles. With conventional transmission or overdrive, the rear axle ratio is 3.56 to 1.

CHASSIS

FRAME: Ladder-type with outward curved side rails, and 5 cross-members. Side rails internally and externally reinforced. Extra-strength x-member for convertible frames.

FRONT SUSPENSION: Independent ball-joint front suspension with swept-back design. Permanently lubricated threaded bushing for upper suspension arms. 10-coil front springs. Full-cushion hydraulic shock absorbers. Rubber-mounted, linkless front torsional stabilizer bar.

REAR SUSPENSION: Splay-mounted leaf-type rear springs. 55-inch long springs all models, except Park Lane, 60 inches. Compression-type shackles. Full-cushion shock absorbers.

STEERING: Ball and rack type gear. Steering shaft straddle-mounted. Over-all steering ratio 31.0 to 1 manual, 24.0 to 1 with optional power.

BRAKES: Internal-expanding, hydraulic type, with self-adjusting brake linings. 11-inch drum. Brake shoe width—3 in. front, 2½ in. rear. Total braking area 233.4 sq. in. Independent mechanical parking brake. Step-on parking brake pedal.

BODY

SEDAN DIMENSIONS: Wheelbase 122 inches, except Park Lane, 125 in. Over-all length 213.2 in., except Park Lane, 220.2 in. Over-all height Monterey and Montclair models 56.6 in.; Park Lane, 56.8 in. Over-all width, 81.0 in. Hip room (f) 61.3 in., (r) 62.9 in. Effective headroom (f) 39.0 in., (r) 38.3 in. Effective leg room (f) 46.2 in., (r) 44.9 in.

STRUCTURE: Welded steel body. Front-hinged hood. Combination bumper-grille. Double-panel door, hood, and deck lid construction. Safety door locks. Two-stop front doors. Dual headlamps. High-level outside air intakes on cowl. Windshield area 1169 sq. in. except Turnpike Cruiser, 1312 sq. in. Total sedan window area, 3991 sq. in.

MAJOR OPTIONS*: Merc-O-Matic with Keyboard Control†, Power-Booster Fan; power steering†; power brakes†, automatic power seat, 4-way power seat, heater-defroster, heater-defroster-air conditioner, overdrive, power-operated windows, power lubrication, tinted windows, nylon tire†, whitewall tires, padded instrument panel†, padded sun visors and seat belts, Air Cushion Ride, dual exhaust†, Super Marauder V-8 engine.

*Optional at extra cost. †Standard on some models.

Mercury Division of Ford Motor Company, Dearborn, Michigan, reserves the right to discontinue or change, at any time, model specifications or design without incurring obligation.