



MinipassionMini.com

It's the image of you



Contents

- 3** Design Classic
- 4** Design Evolution
- 6** New Features
- 10** Mini
- 12** Mini Cooper
- 16** Retro Theme
- 20** Fashion Theme
- 22** Sport Theme
- 26** Luxury Theme
- 30** Accessories
- 32** Merchandise
- 34** Specifications
- 36** Trims and Colours
- 40** Finance



Mini-classless class
Page 10

Mini Cooper
Vrooom, Vrooom!
Page 12

Options/accessories
Design your own Mini!
Page 16

"We made a car that was so unusual that it automatically became a status symbol."

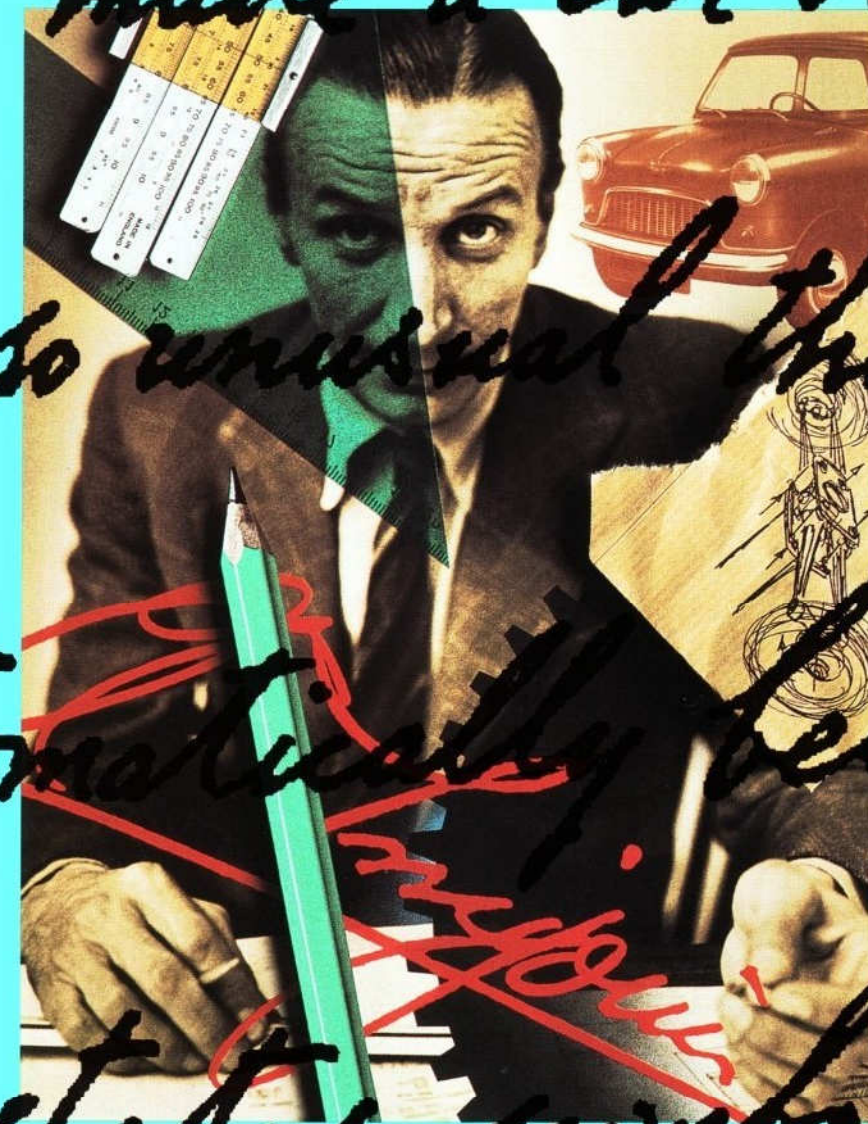

Sir Alec Issigonis, Artist,
Designer, Engineer.

MinipassionMini.com



MinipassionMini.com

Autocar Magazine's readers voted Mini the "Car of the Century" last year. That wouldn't have surprised Sir Alec.



"For anyone between 25 and 45, the Mini was part of growing up. It gave mobility to millions and bankrupted textile mills by leading the way to mini-skirts (sigh)." Peter Sellers, June 1979*



Just as well that Sir Alec Issigonis, Mini's creator, was not put off by failing his maths exam three times at Battersea Technical College. If he had given up trying to become an automotive engineer, the most brilliant idea in the history of the industry would never have seen the light of day. And millions of people would have missed out on the best fun to be had on four wheels.

The man who created one of the design icons of our time was totally unafraid of coming up with ideas that had never been tried before. When Mini appeared in 1959 it was boldly different from

any other car on the road and packed with daring innovations. Other motor manufacturers were quick to copy the ideas; but they've never been able to copy the style.

Sensibly, Mini's makers haven't changed it either. The brand new Mini you can buy today is still the original. Although the latest Mini has major new safety features. And offers you more style choices than you could ever dream of. From the sporty to the retro. From the classically luxurious to the flamboyantly stylish. You've never had a better chance to say who you are.

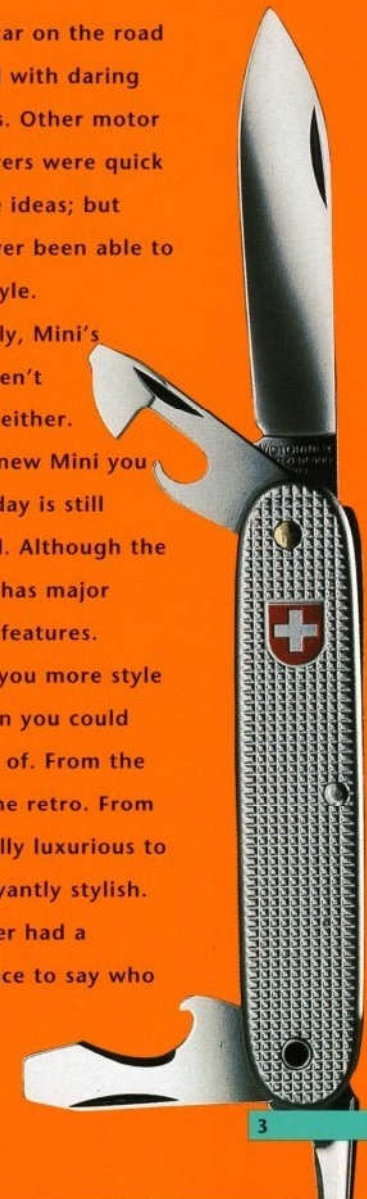



"I've styled my cars so that they couldn't be obsolescent." Sir Alec Issigonis.

Few fashion models look as good at thirty seven as Mini does. Neither do the models that were in the showrooms at the time when Mini first rolled off

friends in the back. You'll be glad to know that the modern Mini is still a lovely little mover. What other car, large or small, could ever

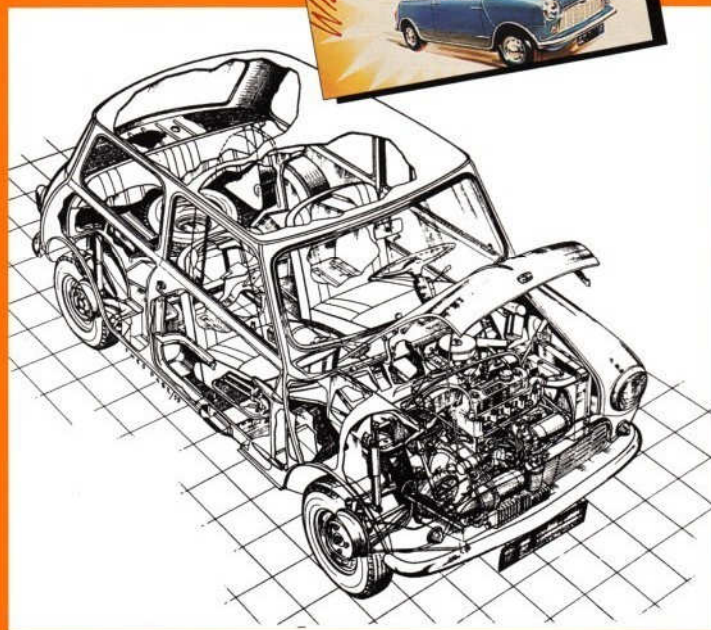
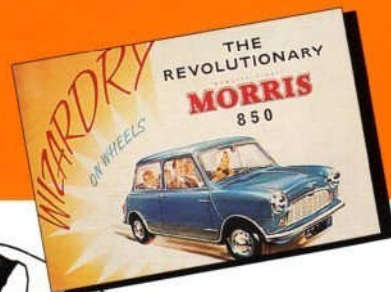

the production line. Mini's cheeky looks are timeless. It's still the essential Mini of more than three and a half decades ago, although more refined and far better equipped.

Today's Mini provides some major new safety features. A driver's airbag is standard. As are sophisticated front seatbelt pre-tensioners, and high strength door side intrusion beams. There's even a headlamp levelling control to keep your lights correctly

aligned when you've got

give you so much fun?

The fun lives on today, with Mini's low centre of gravity, small size and wheel at each corner design helping it to stay glued to the road. But it's the razor sharp response of the steering which does more than anything for the 'tingle factor' of Mini driving. It's quick as a wish and unbelievably accurate. It's also very satisfying. Who doesn't enjoy nipping into the small parking space that others have to pass by? Or slipping into the multi-storey space signed 'Mini's only', next to the Rolls Royce which does not enjoy such exclusive treatment.

"Still no modern car has better steering."

Roger Bell
Journalist



MinipassionMini.com



The new seats in the latest Mini will bend over backwards to make you comfortable, and let your friends into the back seat without a commotion.



The latest Mini comes equipped with a full range of safety features as standard, with a driver's airbag, front seatbelt pre-tensioners and door beams.

All Minis now have twin-point fuel injection.

1.3i

To help keep you safe and sound, Mini now has high strength steel door beams.



Mini's frisky 1275cc engine is the cat's whiskers, now with microchip controlled twin-point fuel injection; it's the same unit that won all those rally victories.



Mini's talents may dazzle you but your headlamps needn't bother other drivers, with the new electric headlamp levelling control.

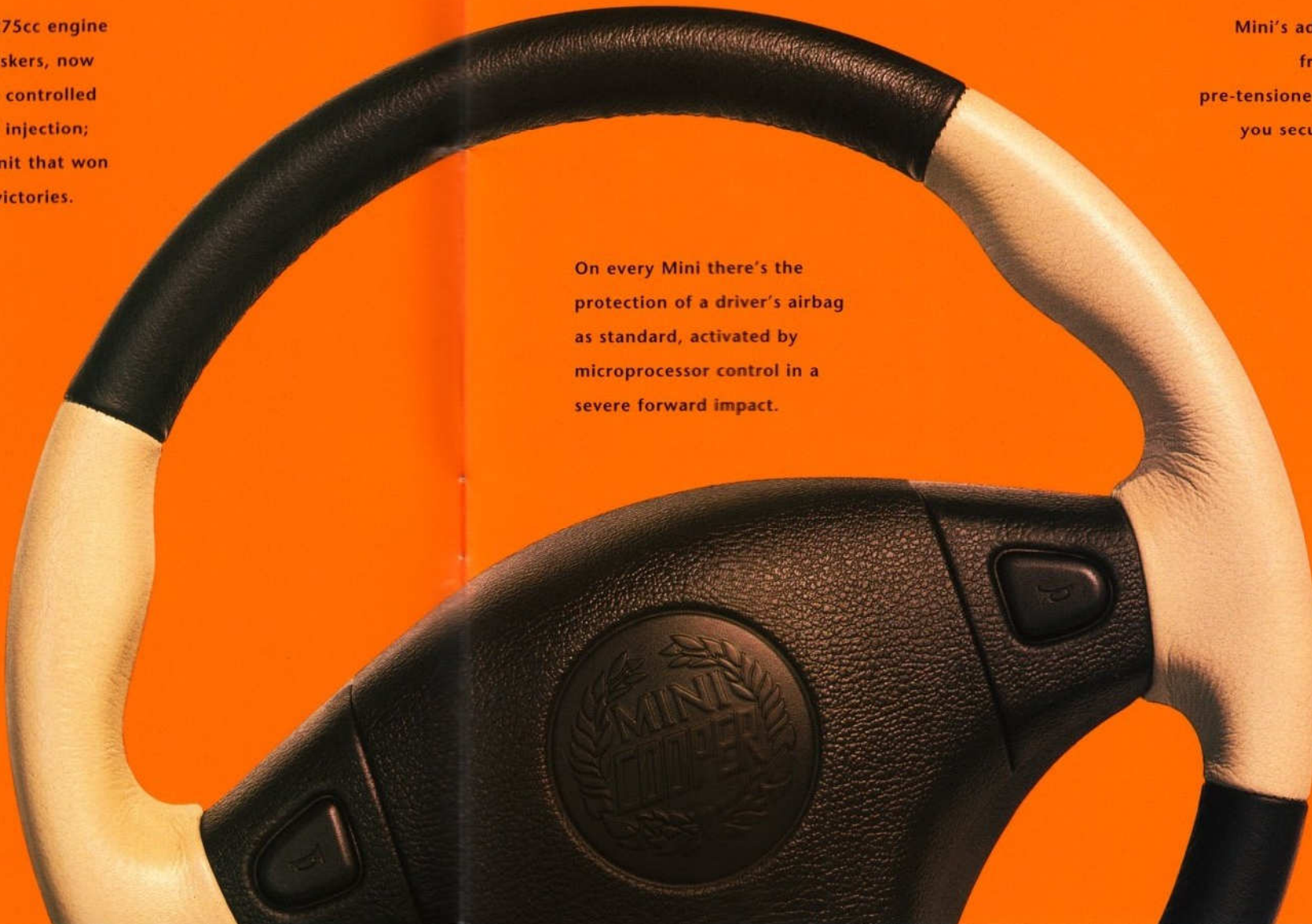

On every Mini there's the protection of a driver's airbag as standard, activated by microprocessor control in a severe forward impact.

Mini's advanced new front seatbelt pre-tensioners help keep you securely seated.

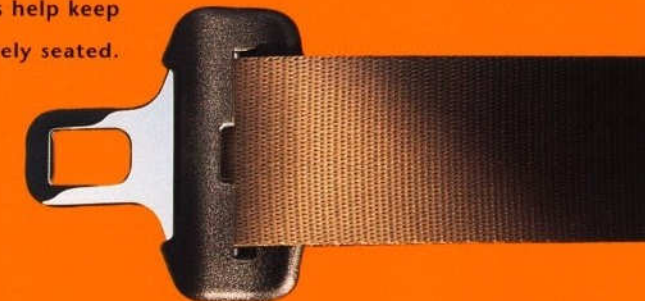

So that you don't get too steamed up, the latest Mini has doubled the number of heater fan speeds from one to two. (After all, a heater wasn't even a standard fit when this hot little number first took to the streets.)



"Thank you
Sir Alec
Issigonis."



John Cooper
Racer/Engineer

MinipassionMini.com

With its unfair advantages on the bends, Mini transformed the appeal of saloon car racing almost overnight. Racing has moved on a great deal since 1959, with its space age technology and armies of mechanics. But that didn't bother Paddy Hopkirk and his Mini Cooper when they returned to the Monte Carlo Rally in 1994.

Throughout the arduous six-day event the French crowds cheered at the spectacular antics of the little car they dubbed 'Le Mini Anglais', as the Cooper fought its way up to win fourth place in its class. Proving yet again that the legend lives on.

“Don't expect me to be modest about the Mini. I'm very proud that it has run for so long and it still looks like the car we designed.” Sir Alec Issigonis.

mini



It's still the original. But the thoroughly modern Mini has a great deal to offer you in addition to sheer fun. It has major new safety features. With a driver's airbag, high strength steel door beams, and front seatbelt pre-tensioners.



Today's Mini is tough on the thief. With a standard anti-theft alarm, passive engine immobilisation, and locking wheel nuts. Plus a security coded in-car audio system with removable faceplate.

And it's beautifully appointed. With a choice of stunning paint colours, tinted glass, and head turning alloy wheels. Slip into stylish new seats with elegant Balmoral facings. Admire the expanse of burr walnut on the dash. Further touches of luxury include the leather trimmed steering wheel and gearknob. Enjoy the sound of the electronic stereo in-car audio system.



Then try to think of any other small car that gives you so much. The Mini 'Wow' factor has never been so strong.



MinipassionMini.com

The Mini Cooper inspires admiration. What other car has taken on so much and won against all the odds, time after time?



cooper



Small, yes. But indomitable. Even before John Cooper worked his magic, Mini was stunningly fast by small car standards. The latest Cooper still leaves its small car rivals trailing. Why shouldn't it flaunt the pedigree?

So it blazes ahead with front driving lamps, wearing the traditional livery of white roof and white bonnet stripes, in addition to the Cooper decals at the rear. Corners with its usual panache, shod with a mouth-watering set of sports alloy wheels bearing the Cooper logo. And entertains as much as ever with the punchy 1275cc power unit. The inside story is just as good . . .

"John Cooper paid me to drive — but he didn't have to."

John Rhodes
Racer



MINI

MinipassionMini.com



When Enzo Ferrari wanted some fun he took to the Italian mountain roads in his Cooper.

The Mini Cooper quickly became a cult. The Aga Khan bought one. So did Steve McQueen and Lord Snowdon.



They would appreciate the latest Cooper even more. The interior is enough to raise your pulse rate even before

you take to the road.

The seats have sporty black Monaco facings. You can have Black or Stone Beige leather seat trim as an option, bearing the Cooper monogram.

Reassuring safety features include a drivers airbag, door beams and front seatbelt pretensioners. Whilst the standard anti-theft alarm, passive engine immobilisation and locking wheel nuts protect against theft. There's also a security coded in-car audio system with removable face-plate.

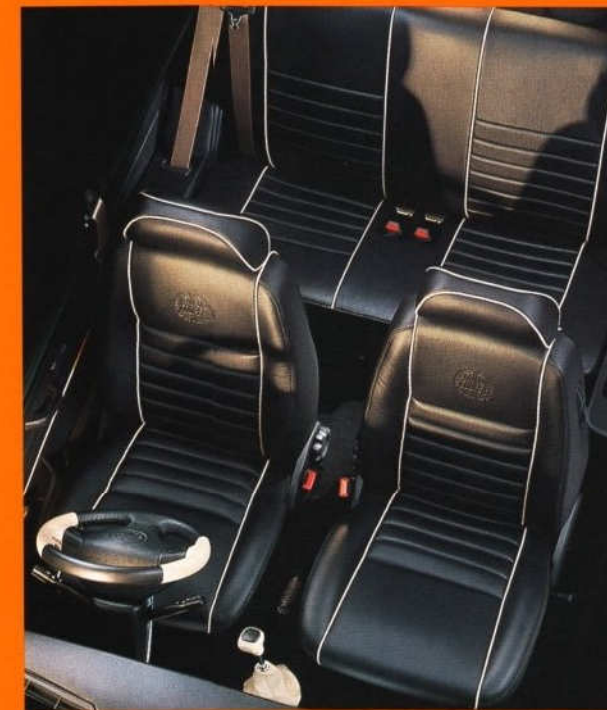

Everywhere you look, you'll approve. Lustrous burr walnut veneer adorns the fascia. The instruments have traditional cream dials. Enjoy the satisfying feel of the leather-trimmed gearknob and sports accelerator pedal.

The Cooper looks just what it is. A car with a sporting tradition that no rival can boast.

So you know you're driving a car which isn't dressed up just for appearance's sake. The Mini Cooper is the real thing.





Mini epitomised the mood of the Swinging Sixties.

Add a retro grille, a Union Jack roof decal, and

“For thousands of us who had to get around London quickly, the Mini was like the answer to a prayer – we stuck wickerwork on the side, rushed it up to Oxford Circus and caned it down Park Lane.” Peter Sellers*

Mini-skirts were driving passing motorists to distraction. Fashion and pop music were being revolutionised.

And Mini was being customised. People treated their Mini as part of their wardrobe. It had to have a particular look all its own.

Now you can do the same. Design your own Mini. You now have the widest choice of style options and accessories ever. Paint colours? There's never been so many. Chrome treatments? Of course. Sports kit? Definitely. Leather trim? Go for it.

On the following pages are some themes which you may like to explore. The Retro look, for example. You can drive nostalgia to the limit. Choose from a range of classic paint colours, lovingly re-created from Mini archives.

chequered bonnet stripes. Fit chrome door mirrors and wipers. And take your pick from a choice of accessory alloy wheel styles that are enough to make Mini rivals ache with envy.

There's no Mini like your Mini. Now you can put together exactly the look you want.



retro



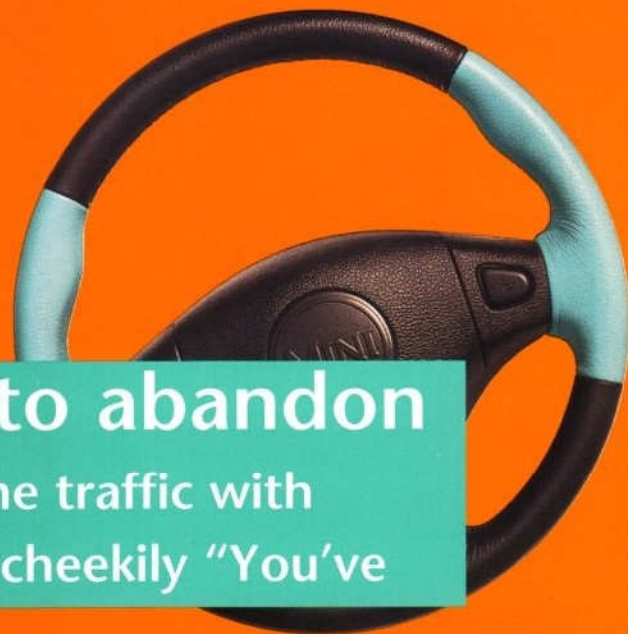

Mini caused the smart set to abandon their Bentleys and dart through the traffic with stickers in their rear windows proclaiming cheekily "You've just been Mini'd."



Create your own Retro Mini, and you can transform the cabin as well as the exterior. You can colour co-ordinate the interior with any of the four classic paint colours. And create a total look inside, from the fascia to the rear seat, and from door to door. The fascia top, steering wheel, gearknob and seats can all be trimmed in matching leather; complemented by a colour-keyed carpet.

Enjoy the traditional look of the alloy door handles, gear lever and instrument surrounds, with oil temperature and battery condition gauges fitted in the fascia. Then go on to choose further individual touches from the biggest range of manufacturer-designed

options and accessories any small car has ever offered.

The Retro theme is just one of many possibilities. On the following pages there are more. But don't feel that you have to follow them slavishly (as if any Mini lover would). Your Mini design adventure is all yours. And Mini's creator would agree.

When Sir Alec designed the Mini, it was a deeply personal enterprise. "The only way to design a car", he expounded, "is to do the whole thing oneself and to have people around you to help you." Now you can design your own Mini. And we're giving you all the help you could wish for.

MinipassionMini.com



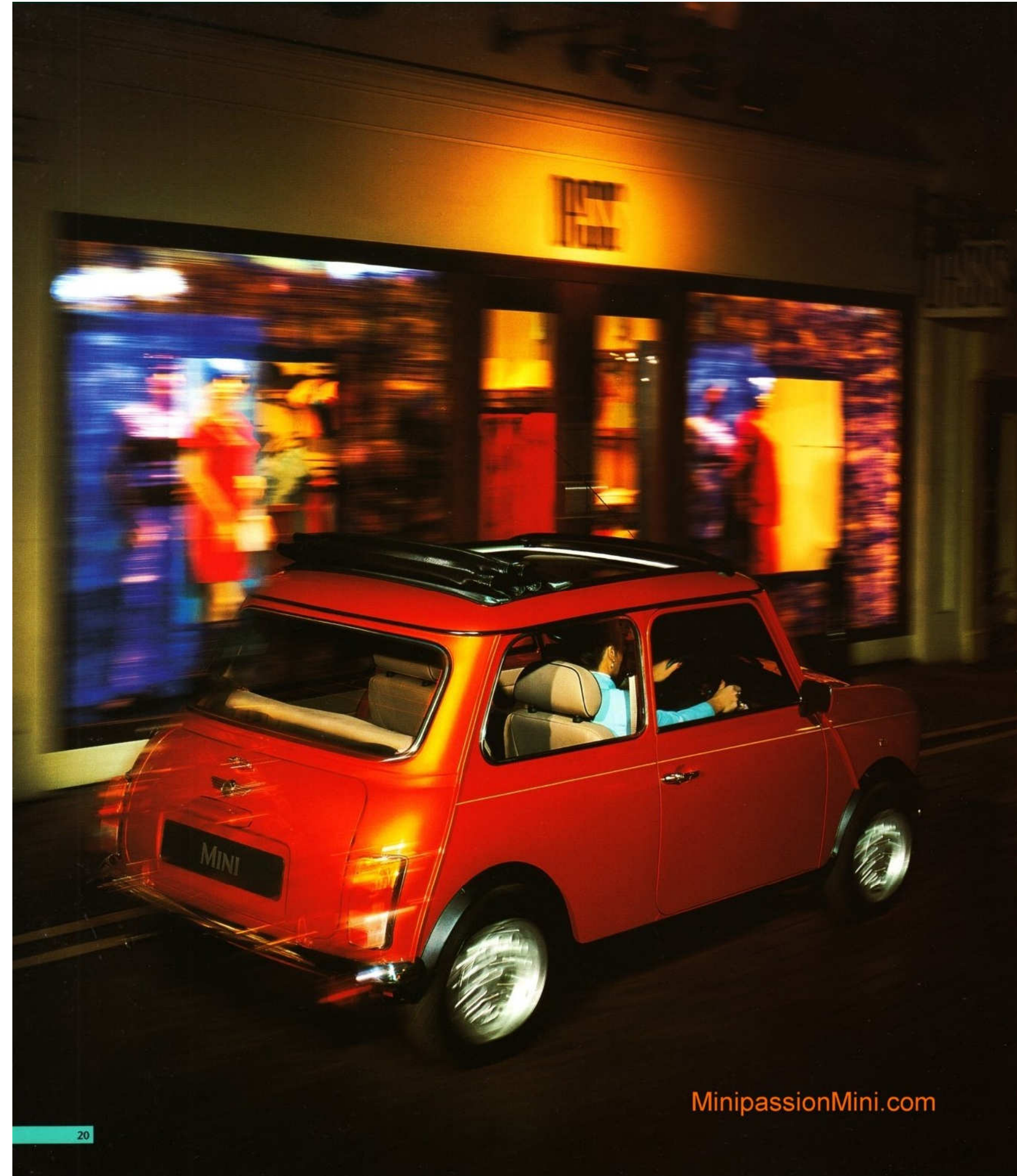

MinipassionMini.com



Mini loves dressing up. Now you can go to town in a style that's all yours. There's no supermodel as fashionable as Mini.



Sir Alec was astonished when what he had designed as a people's car was snapped up by droves of London glitterati. And ever since Peter

Sellers first stuck mock wickerwork on the sides, people have customised their Minis.

Now you can choose from a stunning new wardrobe. Dazzling new paint colours flaunt Mini's "come and get me" looks. Amaranth; a pearlescent purple with an amazing 'flip' which gives it blue notes in sunlight. Volcano; orange like you've never seen it before. Hawaiian; blue has been re-invented.

Get fresh with an electric canvas sunroof which slides back virtually the entire length of the roof. Get into leather – in a choice of optional colours co-ordinated to the bodywork.

Just a few of the possibilities for your new fashion accessory.

a la mode





When the Mini first went rallying, no one believed that a car with so little ground clearance could ever survive. But Mini mixed well with the mud and the rough, as countless larger and more powerful competitors soon found to their dismay. And as Timo Makinen and all the others who piloted low flying Minis to victory would agree.

If you want to underline your Mini's prowess and sporting history, the Sports pack option does the job. We'll fit extremely large, dramatic looking and extra grippy 13" X 6" alloy wheels with low profile tyres and body colour wheelarch spats. You'll also get two auxiliary driving lamps and two front fog lamps for total brilliance on dark bends. And a big bore chrome exhaust pipe finisher.

Inside, you can give extra emphasis to your Mini's sporting personality by adding oil temperature and battery condition gauges. Plus a polished alloy gearknob; complemented by drilled alloy door releases, door pulls and window winders.

There's a fantastic choice of accessory alloy wheels. If you prefer, you can also have an interior in totally colour-keyed leather, from the fascia and steering wheel to the seats and gearknob, with matching carpet. The choice of paint colours includes sporty British Racing Green, Flame Red or the classic Almond Green. Demonstrate that you're at home in the rough with a steel sump guard, Cooper mudflaps and driving lamp covers. Keep fit with Mini, and enjoy yourself.



Mini is small but perfectly formed.

Not the type to have sand kicked in its face.

MinipassionMini.com





A number of police forces used the MK II Cooper S as a patrol car, on the principle that it takes one to catch one.



Sir Alec's brief was to design a car that would "knock all the bubble cars off the road". The Mini Cooper was soon frightening much larger cars on the circuit.



The Mini team won the Monte Carlo rally in 1964, 1965 and 1966 – only to have the prize snatched from their grasp in '66 because of a technicality. In 1967 the team went back to the Monte in a mean mood and wiped the floor with the opposition to clinch the coveted hat-trick.

"One of the most responsive, sensible and just plain wonderful cars ever made."

Paul Skilleter
Journalist

MinipassionMini.com



The early Mini bore all the personal hallmarks of its creator. Sir Alec Issigonis hated radios in cars, so there was no place for a

luxury

Mini wears luxury with the confidence of experience. When you've done so much, you can afford to show off a bit.

radio. Not so today – you can have a CD player if you like. Today's Classic Luxury Mini is loaded with the good things in life.

Express your personality in the body colour; extrovert Volcano perhaps? Or classic British Racing Green? A wonderful choice of five leather trims can be yours; from Cumulus Grey and Porcelain Green to the elegance of Stone Beige. You can continue the look with traditional wooden window winders, door pulls, door cappings and gearknob to complement the burr walnut veneer fascia. Choose a powered canvas sunroof for a real breath of fresh air. Specially styled alloy wheels remind the world that you're driving a little car with a big touch of class.



MinipassionMini.com



"The Only Lovable Car on the road."

Bernd Pischetsrieder
Chairman of BMW

Add the finishing touch to your Cooper's exterior with valve caps bearing the famous logo.



Your Mini is unique. Always different from any other small car – and any other Mini. Reflecting your personality more than any other car can.

Now you can express yourself to the full with Mini accessories, either at



As an additional safety feature, the high mounted stop lamp warns drivers who are too close for comfort.



Fly the flag while you drive the Best of British with a Union Jack roof decal.



accessories...

Express yourself! Your Mini is just as unique as you are. Now you can tell the world.

Continue the sporting theme inside with aluminium alloy door releases and window winders and a polished alloy gearknob.



the time you order your new Mini or at any time afterwards.

You can find out more by asking for the Mini Accessories brochure at your local Rover dealer. They'll also be happy to talk to you about the many other ways you can theme your Mini.

All these items have been specially designed for Mini, and thoroughly tested and approved. So you can be completely confident that you've got the right kit for your best friend.



You want alloy wheels, we got 'em. White, Charcoal, Revolution – take your pick. These are just a few from our selection.



Winning Mini makes the message clear with a chequered roof decal and bonnet stripes.

Add a retro grille, driving lamps and retro bumpers to complement the classic Almond Green paint finish. If you've got one, flaunt it.



Fit stunning white painted alloy wheels and complete the look with chrome sills and spats.

MinipassionMini.com

Write on! This beautiful chrome finished ballpoint pen handles as perfectly as the Mini itself!



Mini proved that small is beautiful - just like this finely machined lighter.

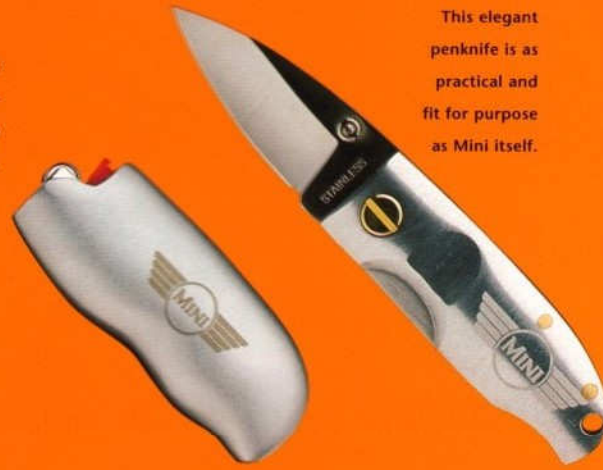

This elegant penknife is as practical and fit for purpose as Mini itself.



A highly detailed 'mini-mini-mini' version of the classic 1965 Monte Carlo Rally Car.

Mini's good at getting out of tight corners. This multi-purpose tool is the ultimate survival kit for tricky situations.

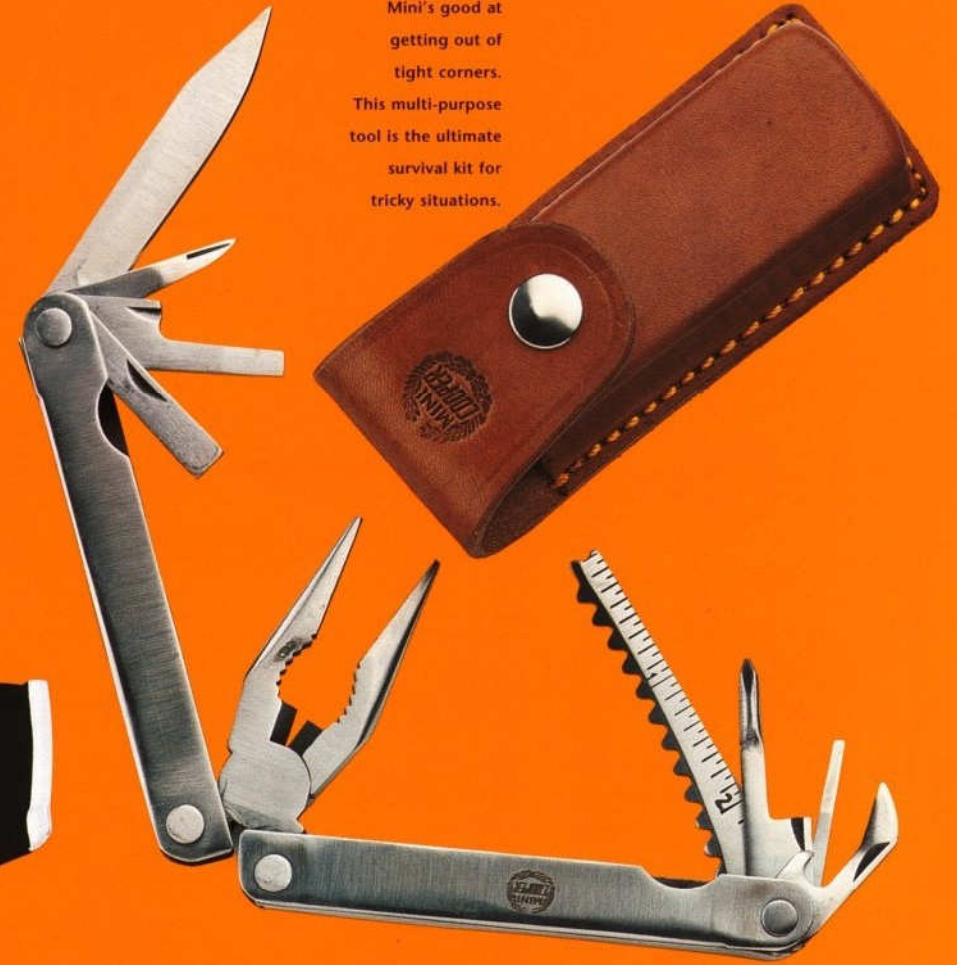

...mini mania

Live your Mini! Surround yourself with stunningly designed items that reflect the personality and uniqueness of your one and only.

If Mini was a penknife, what would it look like? Now you know. This unique collection is small but perfectly formed, like the car itself. Brilliantly conceived, beautifully finished and made from top quality materials.

The Mini collection ranges from the superbly practical and stylish to the downright wacky. Every item carries the Mini logo, naturally. Now you can have fun with the car of your life even when you're not at the wheel.

Enjoy a close shave as much as Mini does with this compact, beautifully made kit.

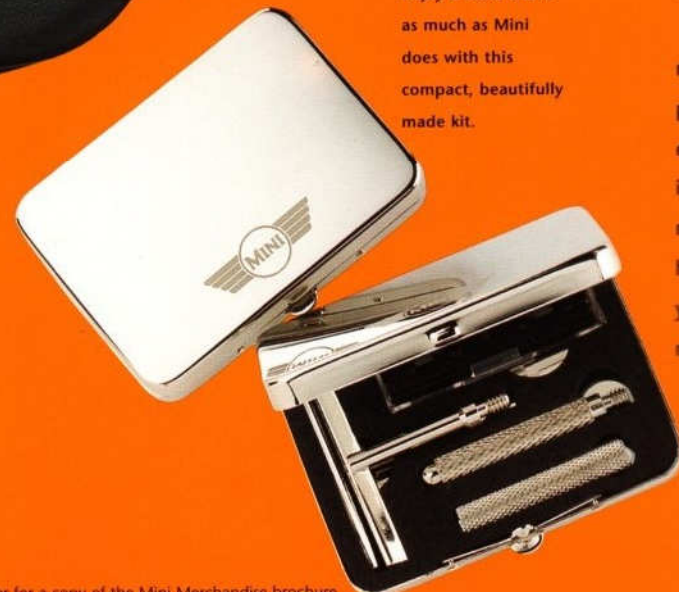

New York, London, Paris...? Wherever you are, time won't pass you by with the Navigator Alarm Clock - a precision time piece with a rotating outer rim to show times across the world.



Party on in this fitted T-shirt! - up to the minute chic with the new Mini logo emblazoned on it.

You know you look good driving your Mini, now you can be sure of looking good when you're not, with one of these stylish denim shirts!



MinipassionMini.com

STANDARD ON ALL MODELS

INSTRUMENTATION AND CONTROLS

- Speedometer, tachometer and fuel level and water temperature gauges.
- Analogue clock.
- Cream coloured instrument faces with chrome surrounds.
- Warning lamps for direction indicators, main beam, ignition/no charge, low oil pressure, brake circuit failure, heated rear window, rear fog guard lamp, 'SRS' and alarm LED.
- Two column stalks for indicators, horn, headlamp dip/main beam/flash, 2 speed wipers with flick wipe, intermittent wipe and electric screen washers.
- Heated rear window, brake circuit test, horn push, hazard warning lamps and rear fog guard lamp switches.
- Headlamp levelling switch.



HEATING AND VENTILATION

- Fresh air heater/demister with 2 speed fan and 2 adjustable face level air vents.

LIGHTING

- Halogen headlamps.
- Twin reversing lamps.
- Rear fog guard lamp.
- Side repeater flashers.
- Interior courtesy lamp.



SAFETY

- Driver's airbag.
- Side intrusion beams in doors.
- Upholstered front seat head restraints.
- Inertia reel front seat belts with pre-tensioners.
- Inertia reel rear seat belts.
- Laminated windscreen.

Engine and Transmission Availability

	Mini 1.3i	Mini Cooper 1.3i
1.3i	■	■
4 speed manual transmission	■	■

Engine

	Max. Power	Max. Torque	Engine Data
1.3i	63 Ps (EEC) @ 5500 rpm	95 Nm (EEC) @ 3000 rpm	1275cc, 4 cylinder, transverse, OHV with electronic twin-point fuel injection and 3-way controlled catalyst. Compression ratio 10.5:1.

Performance and Fuel Economy*

Model	Transmission	Maximum Speed (mph)	Acceleration (secs)			Urban		Extra Urban		Combined	
			0-60mph	30-50mph (4th gear)	50-70mph (4th gear)	Mpg L/100km	Mpg L/100km	Mpg L/100km	Mpg L/100km	Mpg L/100km	
Mini/Mini Cooper	Manual	90	12.2	12.5	16.2	33.4	8.5	51.8	5.5	43.0	6.6

*Manufacturer's data.

All fuel economy figures are produced in accordance with Directive 93/116/EC. They have been calculated using the same test cycle as used for official exhaust emission classification. They cannot be compared with the previous steady speed/urban figures and are more representative of actual on-road fuel consumption. Under normal use a car's actual fuel consumption figures may differ from those achieved through the test procedure, depending on driving technique, road and traffic conditions, environmental factors, and vehicle condition. Mini models are equipped with a 3-way controlled catalytic converter and must use unleaded fuel. The use of Premium (95 RON) unleaded fuel is recommended. Unleaded petrol of a higher octane can be used. Fuel tank capacity: 7.5 gallons (34 litres).

Suspension

Front: Independent, wishbone with unequal length upper and lower arms operating against rubber cone springs. Telescopic hydraulic dampers. Rear: Independent, trailing arms operating against rubber cone springs. Telescopic hydraulic dampers.

Steering

Rack and pinion. Turning circle 28.2 ft (8.6m).

Brakes

Servo-assisted, diagonal split dual circuit system, discs front, drums rear.

Wheels and Tyres

Mini: 12" Premium style alloy wheels with 145/70 SR12 radial ply tyres and locking wheel nuts. Steel spare wheel.
Mini Cooper: 12" Sports style alloy wheels with 145/70 SR12 radial ply tyres and locking wheel nuts. Steel spare wheel.

Comfort and Convenience

	Mini	Mini Cooper
Black leather trimmed steering wheel.	■	-
Black/Beige leather trimmed steering wheel.	-	■
Full width burr walnut fascia incorporating glovebox, radio/cassette, analogue clock and instrument pack.	■	■
Burr walnut door and rear quarter cappings.	□	□
Moulded handbrake grip.	■	■
Chrome gear lever with beige leather trimmed gearknob.	■	■
Alloy gearknob.	△	△
Wood gearknob.	△	△
Drilled bright finish accelerator pedal.	-	■

Alloy Accessory Pack

Window winders. Door pulls. Door release. △ △

Wood Accessory Pack

Door cappings. Door pulls. Door release. Window winders. △ △

Colour-keyed Leather Accessory Pack (available in Tartan Red, Horizon Blue or Porcelain Green)

Gearknob. Handbrake grip. Steering wheel. Header rail. Parcel shelf finisher. △ △

Seating

	Mini	Mini Cooper
Balmoral seat facings with colour-keyed carpets.	■	-
Monaco seat facings with black carpets.	-	■
Beige leather seat facings.	□	□
Black leather seat facings.	-	□
Classic leather seat facings with colour-keyed carpets, door casings and companion boxes and black steering wheel, gearknob and seat belts.	□	□

In-Car Entertainment

Electronic tune 3 band stereo radio/stereo cassette (R660) with security code theft deterrent, detachable key pad, auto reverse, Autostore, separate tone and balance controls and 2 speakers. ■ ■
Roof mounted aerial. ■ ■

Body Features

Body colour door mirrors (except Anthracite).	■	-
White door mirrors.	-	■
Tinted glass.	■	■
Chrome bumpers.	■	■
Chrome effect grille.	■	-
Chrome effect sports grille.	-	■
Chrome door and boot handles.	■	■
Chrome tailpipe finisher.	■	-
Bright windscreen and window surrounds.	■	■
Bright waist finishers.	■	■
Opening rear quarter windows.	■	■
Single coachline.	■	-
Twin coachline.	-	■
Black wheelarch extensions.	■	■
Black roof finisher.	■	■
Mini bonnet and bootlid badges.	■	■
Cooper decals on rear wings.	-	■
White roof with matching bonnet stripes.	-	■
Front driving lamps.	-	■
Electric canvas sunroof.	□	□
Union Jack roof decal.	△	△
Chequered roof decal.	△	△
Chequered bonnet stripes.	△	△
Classic solid paint finish.	□	□
Clearcoat metallic paint finish.	□	□
Pearlescent paint finish.	□	□
Comprehensive anti-corrosion treatment with 6 year warranty*.	■	■

Sports Option Pack

Additional gauges in fascia. 13" x 6" Sports Style alloy wheels. 175/50 R13 radial ply tyres. Large body colour extended wheelarches. 2 driving lamps. † 2 fog lamps. □ □
Sports accelerator pedal†. Large bore chrome tailpipe finisher.

Exterior Bright Accessories Pack

Pack 1: 'Retro' style grille. Chrome bumper overriders and corner bars. △ △
Pack 2: Polished wiper arms. Chrome door mirrors. Chrome exhaust finisher. △ △

Insurance Group

(As recommended by the Association of British Insurers) 5 5

Servicing Intervals

6 months/6,000 miles, whichever occurs first, 12 months/12,000 miles, then every 12 months/12,000 miles thereafter.
■ Standard Features □ Optional Features △ Dealer Fit Accessory. * Conditions apply. Please ask your dealer for details.
† Standard on Mini Cooper. Note: These specifications apply to UK models. Specifications for other markets may vary and are available on request. Certain specifications are built to Customer Special Order. For delivery availability information, please consult your Rover Dealer.
△ The Dealer Fit Accessory items listed are only a selection of the accessories available and are also available independently of the packs described. Please refer to the Mini Accessories brochure for further details. N.B. The Mini is not approved for use as a towing vehicle.

STANDARD ON ALL MODELS

COMFORT AND CONVENIENCE

- 3-spoke soft feel leather trimmed steering wheel.
- Fully carpeted interior.
- Heated rear window.
- Vinyl trimmed door and quarter casings.
- Twin sun visors with passenger's vanity mirror.
- Front ashtray.
- Twin door bins.
- Rear companion boxes.
- Gear lever gaiter.
- Boot mat.
- Internal bonnet release.



SEATING

- Reclining, tilting, front seats.
- Height adjustable, upholstered front seat head restraints.
- Seat back map pockets.



SECURITY

- Perimetric anti-theft alarm with passive engine immobiliser.
- Remote activation of alarm and immobiliser.
- Security coded radio/cassette with detachable keypad.
- Locking fuel filler cap.
- Windscreen security etching.



Paintwork and upholstery

Exterior colours

	Mini	Mini	Mini	Mini Cooper	Mini Cooper	Mini Cooper
Solid colours	Balmoral Trim	Carpet Colour	Leather Trim*	Monaco Trim	Carpet Colour	Leather Trim*
Flame Red	Stone Beige	Red	Stone Beige	Black/Light Stone Beige	Black	Black or Stone Beige
White Diamond	Stone Beige	Blue	Stone Beige	-	-	-
Clearcoat Metallic colours*						
Anthracite	Stone Beige	Red	Stone Beige	Black/Light Stone Beige	Black	Black or Stone Beige
Platinum Silver	Stone Beige	Red	Stone Beige	-	-	-
Hawaiian Blue	Stone Beige	Blue	Stone Beige	Black/Light Stone Beige	Black	Black or Stone Beige
British Racing Green	Stone Beige	Green	Stone Beige	Black/Light Stone Beige	Black	Black or Stone Beige
Pearlescent colours*						
Nightfire Red	Stone Beige	Red	Stone Beige	Black/Light Stone Beige	Black	Black or Stone Beige
Tahiti Blue	Stone Beige	Blue	Stone Beige	Black/Light Stone Beige	Black	Black or Stone Beige
Amaranth	Stone Beige	Black	Stone Beige	Black/Light Stone Beige	Black	Black or Stone Beige
Volcano	Stone Beige	Black	Stone Beige	Black/Light Stone Beige	Black	Black or Stone Beige

Classic colours*

Almond Green	Stone Beige	Green	Stone Beige	Black/Light Stone Beige	Black	Black or Stone Beige
Surf Blue	Stone Beige	Blue	Stone Beige	Black/Light Stone Beige	Black	Black or Stone Beige

Mini and Mini Cooper have colour co-ordinated carpets. Colour of carpet shown against each colour of car ie. Red Mini comes with Red carpet, British Racing Green Mini Cooper has a black carpet, etc.

Optional Classic leather trim availability**

	Porcelain Green Green Carpet	Horizon Blue Blue Carpet	Cumulus Grey Red Carpet	Tartan Red Red Carpet
Solid colours				
Flame Red	-	-	○	-
White Diamond	○	○	○	○
Clearcoat Metallic colours*				
Anthracite	-	-	○	○
Platinum Silver	-	-	○	-
Hawaiian Blue	-	○	-	-
British Racing Green	○	-	-	-
Pearlescent colours*				
Nightfire Red	-	-	○	-
Tahiti Blue	-	○	-	-
Amaranth	-	-	○	-
Volcano	-	-	○	-
Classic colours*				
Almond Green	○	-	-	-
Surf Blue	-	○	-	-

Metallic paint contains particles of aluminium flake, making the colour appear to change shade under different light conditions. Pearlescent paint contains translucent mica particles, giving the illusion of constantly changing, shimmering colour under different light conditions.

* Optional at extra cost.

**Includes colour-keyed carpets, door casings and companion boxes, and black steering wheel, gearknob and seat belts.

○ Availability of classic leather trim with exterior paint colour.

MinipassionMini.com

CLASSIC LEATHER



Cumulus Grey



Porcelain Green



Tartan Red



Horizon Blue



MINI

BALMORAL
Stone Beige

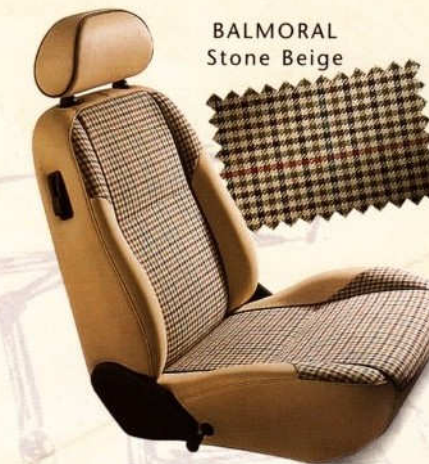

LEATHER
Stone Beige



MINI COOPER

MONACO
Light Stone Beige



LEATHER
Black

Stone Beige



COLOUR-KEYED CARPETS

Black

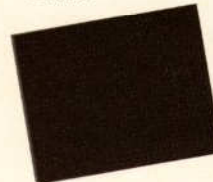

Red



Green



Blue



Solid colours



Flame Red



White Diamond

Clearcoat Metallic colours*



Anthracite



Platinum Silver



Hawaiian Blue



British Racing Green

Pearlescent colours*



Nightfire Red



Tahiti Blue



Amaranth



Volcano

Classic colours*



Almond Green



Surf Blue

*Optional at extra cost



Mini Premium style alloy wheel.



Mini Cooper Sports style alloy wheel.



Optional Sports style alloy wheel.

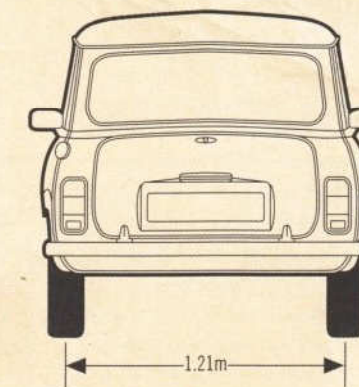
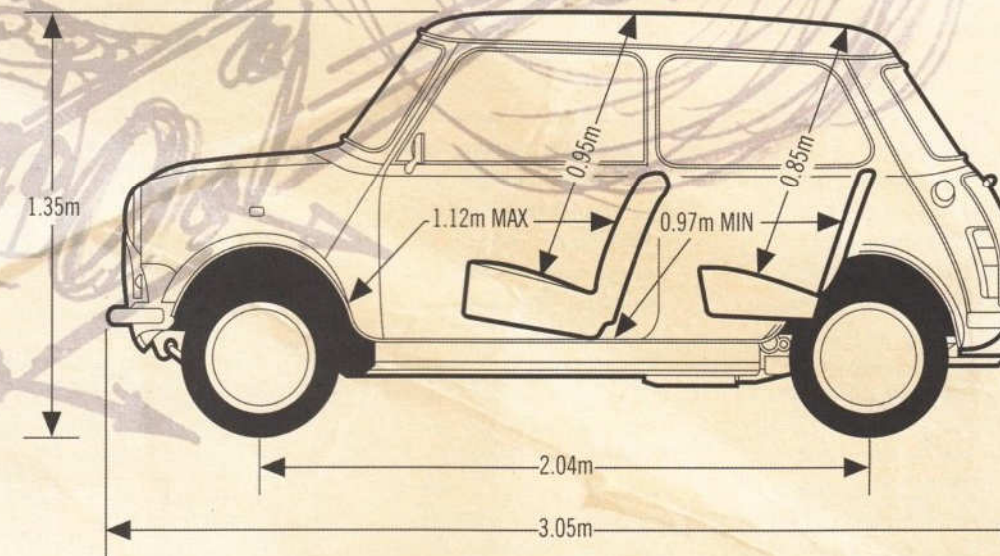
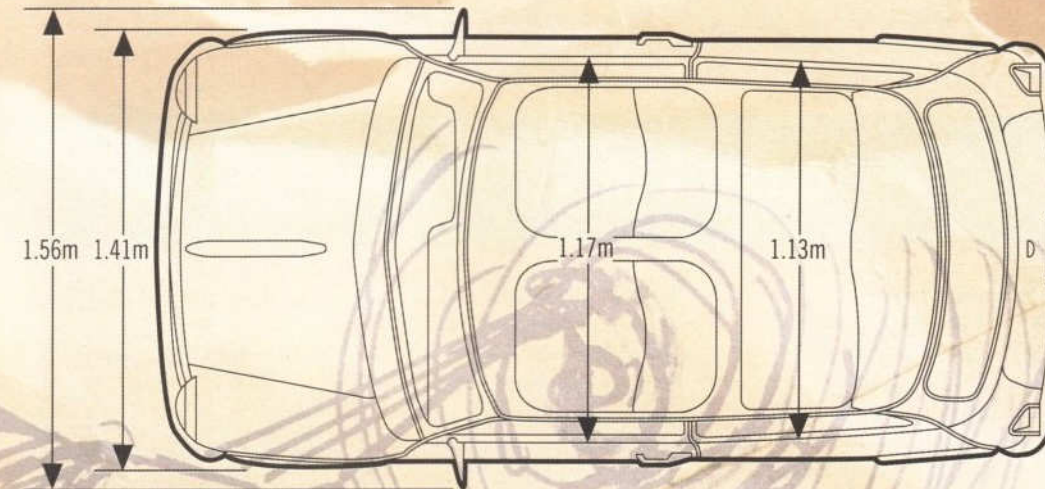

EXTERIOR DIMENSIONS

Height	1.35m (53.25in)
Wheelbase	2.04m (80.10in)
Length	3.05m (120.25in)
Width (excluding door mirrors)	1.41m (55.50in)
Width (including door mirrors)	1.56m (61.30in)
Track (front)	1.24m (48.80in)
Track (rear)	1.21m (47.40in)

INTERIOR DIMENSIONS

Front headroom	0.95m (37.5in)
Rear headroom	0.85m (33.5in)
Max. front legroom	1.12m (44.0in)
Min. rear legroom	0.97m (38.5in)
Front shoulder room	1.17m (46.0in)
Rear shoulder room	1.13m (44.5in)
Luggage capacity	0.12cu.m. (4.1cu.ft.)

You could be surprised at how easy it is to fit your new Mini into your budget. Rover Select gives you the opportunity of driving a new Rover every two years. Yet the monthly

You simply pay a deposit; this is normally between 10% – 30% of the total cost and could be covered by the part exchange allowance on your current car.

Rover. Then you simply begin another flexible Rover Select agreement.

Your second choice is to pay the final payment and keep the car. Or, thirdly, you

Your route to your new Mini.

repayments are substantially lower than with conventional finance plans. And you can relax, safe in the knowledge that you will have Guaranteed Minimum Equity at the end of the agreement, which you can use as a deposit for your next car.

You and your Rover dealer work out the mileage you expect to cover in the car each year. Your dealer then quotes you a Guaranteed Minimum Future Value (GMFV) for your car. You decide how much of your GMFV will be a final payment and how much will be your Guaranteed Minimum Equity – this can be as much as your original deposit.

These figures, combined with the deposit, are used to calculate the remaining balance and your monthly repayments. You can select a two or three year repayment period. Your monthly repayments cover the interest on the balance, the balance itself and the interest on the final payment. The example opposite shows just how little the monthly repayments can be.

At the end of the repayment period, as long as you haven't exceeded the agreed mileage and the car is in good condition for its age, you have three choices. Firstly, you can use your Guaranteed Minimum Equity as a deposit for another Rover. And if your car is worth more in part-exchange than the GMFV, you'll have even more cash for your next

can return the car with no more to pay. Just hand over the keys and walk away.

If you want all the pleasure of driving a brand new Mini, but would like all the ownership aspects taken care of for you, the Rover Personal Contract Hire scheme is the answer. For a modest monthly payment, the scheme allows you to cover nearly all aspects of running a Mini.

Why shouldn't you have the same peace of mind when buying a car as you would with virtually any other product? Rover think you should.

The Rover Commitment 30 day Exchange/Refund offer is simple. If for any reason you're not completely satisfied with your new Mini, you can return it within 30 days or 1,000 miles, whichever comes first. You can exchange it for an identical model (if one is available) or, by paying the difference, an upgraded model. Or you can receive a full refund. If you've paid cash or obtained finance through Rover Finance, there's no cancellation charge. All the details, terms and conditions are set out in The Rover Commitment Handover Document.

ROVER PERSONAL CONTRACT HIRE

THE FACTS

With Rover Personal Contract Hire, you can drive a brand new Mini every two or three years with complete peace of mind. All your servicing and maintenance are taken care of, and your new Mini will also be covered by a comprehensive roadside assistance package from the Automobile Association. So relax and enjoy the drive.

Typical 3 Year Example –
Initial Payment £620.00
Followed by 35 monthly payments of £207.00

All payments shown are correct at time of printing, are inclusive of VAT at 17.5%, cost of delivery to dealer, number plates, maintenance, AA cover and road fund licence for three years.

Further charges may be made subject to mileage, condition and vehicle not being returned.

Example assumes annual mileage of up to 6,000 miles. Subject to vehicle availability. Leasing available to anyone aged 18 or over, subject to status. A guarantee may be required.

Written quotations available on request from Rover Finance.

ROVER SELECT TYPICAL EXAMPLE

'ON THE ROAD' PRICE*	£9,095.00
DEPOSIT (30%)	£2,715.00
AMOUNT OF CREDIT	£6,380.00
24 MONTHLY PAYMENTS**	£189.00
FINAL PAYMENT	£3,400.00
GUARANTEED MINIMUM FUTURE VALUE†	£4,400.00
GUARANTEED MINIMUM EQUITY‡	£1,000.00
CHARGE FOR CREDIT	£1,616.00
TOTAL PAYABLE	£10,711.00

APR. 17.0%

* Price correct at time of printing. Includes 12 months Road Fund Tax.

** A Credit Facility Fee of £59 and a Sales Agency Fee of £1 are added to the first payment.

** Provided the vehicle has not exceeded the agreed mileage and is in good condition.

Example assumes annual mileage up to 6,000 miles.

Credit available to anyone aged 18 or over, subject to status, (a guarantee may be required) through Rover Finance Ltd., Avon House, 435 Stratford Road, Shirley, Solihull, B90 4BL.

(A member of NatWest Group).
Written quotations available on request.

MinipassionMini.com



DEALER STAMP

MinipassionMini.com



We wish to thank Classic and Sportscar Magazine for allowing us to use quotes from their April 1996 Issue.

Important Notice: Rover Group is constantly seeking ways to improve the specification, design and production of its vehicles and alterations take place continually. Whilst every effort is made to produce up to date literature, this UK market brochure should not be regarded as an infallible guide to current specifications, nor does it constitute an offer for the sale of any particular vehicle. Distributors and Dealers are not agents of Rover Group and have absolutely no authority to bind Rover Group by any express or implied undertaking or representation. Any offers referred to in this brochure relating to Optional Warranty, Insurance Scheme, Car Rental Facility, Car Finance Facility and Rover Commitment are only available in the United Kingdom. An alternative Car Finance Facility is however available in Ireland, full details of which are available from your Rover dealer. Any reference in this brochure to speed or performance should not be taken as an encouragement to drive either dangerously or at speeds in excess of the national limit.

Fuel specifications used in this brochure refer to current production models. If in any doubt, please consult your dealer.

Mini Cars is part of Rover Group.

Rover Group, International Headquarters, Warwick Technology Park, Warwick CV34 6RG.

www.mini.co.uk

**For further information on Mini products contact Mini Customer Service on 0800 646 485.
Your calls may be recorded and monitored for information purposes.**

© Rover Group Limited 1998.